

Version 1.0

Published August 2013

Copyright©2013 ASRock INC. All rights reserved.



Copyright Notice:

No part of this documentation may be reproduced, transcribed, transmitted, or translated in any language, in any form or by any means, except duplication of documentation by the purchaser for backup purpose, without written consent of ASRock Inc.

Products and corporate names appearing in this documentation may or may not be registered trademarks or copyrights of their respective companies, and are used only for identification or explanation and to the owners' benefit, without intent to infringe.

Disclaimer:

Specifications and information contained in this documentation are furnished for informational use only and subject to change without notice, and should not be construed as a commitment by ASRock. ASRock assumes no responsibility for any errors or omissions that may appear in this documentation.

With respect to the contents of this documentation, ASRock does not provide warranty of any kind, either expressed or implied, including but not limited to the implied warranties or conditions of merchantability or fitness for a particular purpose.

In no event shall ASRock, its directors, officers, employees, or agents be liable for any indirect, special, incidental, or consequential damages (including damages for loss of profits, loss of business, loss of data, interruption of business and the like), even if ASRock has been advised of the possibility of such damages arising from any defect or error in the documentation or product.

The terms HDMI™ and HDMI High-Definition Multimedia Interface, and the HDMI logo are trademarks or registered trademarks of HDMI Licensing LLC in the United States and other countries.



This device complies with Part 15 of the FCC Rules. Operation is subject to the following two conditions:

- (1) this device may not cause harmful interference, and
- (2) this device must accept any interference received, including interference that may cause undesired operation.

CALIFORNIA, USA ONLY

The Lithium battery adopted on this motherboard contains Perchlorate, a toxic substance controlled in Perchlorate Best Management Practices (BMP) regulations passed by the California Legislature. When you discard the Lithium battery in California, USA, please follow the related regulations in advance.

“Perchlorate Material-special handling may apply, see www.dtsc.ca.gov/hazardouswaste/perchlorate”

ASRock Website: <http://www.asrock.com>

Motherboard Layout

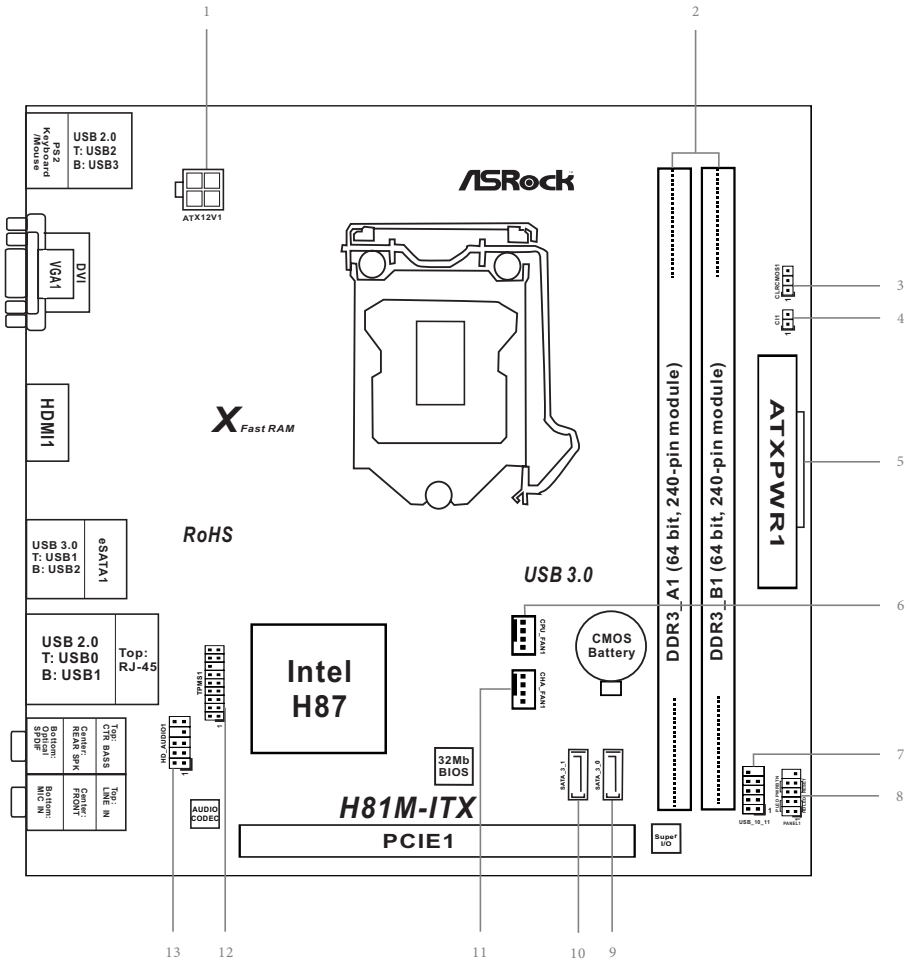

No.	Description
1	ATX 12V Power Connector (ATX12V1)
2	2 x 240-pin DDR3 DIMM Slots (DDR3_A1, DDR3_B1)
3	Clear CMOS Jumper (CLRCMOS1)
4	Chassis Intrusion Header (CI1)
5	ATX Power Connector (ATXPWR1)
6	CPU Fan Connector (CPU_FAN1)
7	USB 2.0 Header (USB10_11)
8	System Panel Header (PANEL1)
9	SATA3 Connector (SATA3_0)
10	SATA3 Connector (SATA3_1)
11	Chassis Fan Connector (CHA_FAN1)
12	TPM Header (TPMS1)
13	Front Panel Audio Header (HD_AUDIO1)

I/O Panel

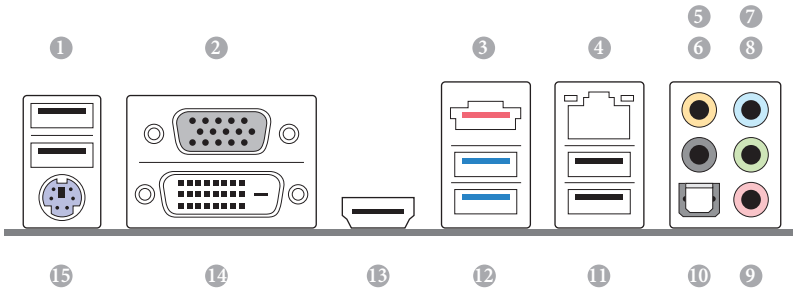

No.	Description	No.	Description
1	USB 2.0 Ports (USB_23)	9	Microphone (Pink)
2	VGA Port	10	Optical SPDIF Out Port
3	eSATA Connector***	11	USB 2.0 Ports (USB_01)
4	LAN RJ-45 Port*	12	USB 3.0 Ports (USB3_12)
5	Central / Bass (Orange)	13	HDMI Port
6	Rear Speaker (Black)	14	DVI-D Port
7	Line In (Light Blue)	15	PS/2 Mouse/Keyboard Port
8	Front Speaker (Lime)**		

* There are two LEDs on each LAN port. Please refer to the table below for the LAN port LED indications.

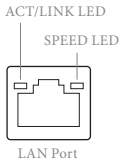

Activity / Link LED		Speed LED	
Status	Description	Status	Description
Off	No Link	Off	10Mbps connection
Blinking	Data Activity	Orange	100Mbps connection
On	Link	Green	1Gbps connection

** If you use a 2-channel speaker, please connect the speaker's plug into "Front Speaker Jack". See the table below for connection details in accordance with the type of speaker you use.

Audio Output Channels	Front Speaker (No. 8)	Rear Speaker (No. 6)	Central / Bass (No. 5)	Line In (No. 7)
2	V	--	--	--
4	V	V	--	--
6	V	V	V	--
8	V	V	V	V



To enable Multi-Streaming, you need to connect a front panel audio cable to the front panel audio header. After restarting your computer, you will find the "Mixer" tool on your system. Please select "Mixer ToolBox" , click "Enable playback multi-streaming", and click "ok". Choose "2CH", "4CH", "6CH", or "8CH" and then you are allowed to select "Realtek HDA Primary output" to use the Rear Speaker, Central/Bass, and Front Speaker, or select "Realtek HDA Audio 2nd output" to use the front panel audio.

*** The eSATA connector supports SATA with cables within 1 meters.

Chapter 1 Introduction

Thank you for purchasing ASRock H81M-ITX motherboard, a reliable motherboard produced under ASRock's consistently stringent quality control. It delivers excellent performance with robust design conforming to ASRock's commitment to quality and endurance.



Because the motherboard specifications and the BIOS software might be updated, the content of this documentation will be subject to change without notice. In case any modifications of this documentation occur, the updated version will be available on ASRock's website without further notice. If you require technical support related to this motherboard, please visit our website for specific information about the model you are using. You may find the latest VGA cards and CPU support list on ASRock's website as well. ASRock website <http://www.asrock.com>.

1.1 Package Contents

- ASRock H81M-ITX Motherboard (Mini-ITX Form Factor)
- ASRock H81M-ITX Quick Installation Guide
- ASRock H81M-ITX Support CD
- 2 x Serial ATA (SATA) Data Cables (Optional)
- 1 x I/O Panel Shield

1.2 Specifications

- Platform**
- Mini-ITX Form Factor
 - All Solid Capacitor design

- A-Style**
- Home Cloud

- CPU**
- Supports 4th Generation Intel® Core™ i7 / i5 / i3 / Xeon® / Pentium® / Celeron® in LGA1150 Package
 - 4 Power Phase Design
 - Supports Intel® Turbo Boost 2.0 Technology

- Chipset**
- Intel® H81

- Memory**
- Dual Channel DDR3 Memory Technology
 - 2 x DDR3 DIMM slots
 - Supports DDR3 1600/1333/1066 non-ECC, un-buffered memory
 - Max. capacity of system memory: 16GB (see CAUTION)
 - Supports Intel® Extreme Memory Profile (XMP)1.3/1.2

- Expansion Slot**
- 1 x PCI Express 2.0 x16 slot

- Graphics**
- Intel® HD Graphics Built-in Visuals and the VGA outputs can be supported only with processors which are GPU integrated.
 - Supports Intel® HD Graphics Built-in Visuals : Intel® Quick Sync Video with AVC, MVC (S3D) and MPEG-2 Full HW Encode1, Intel® InTru™ 3D, Intel® Clear Video HD Technology, Intel® Insider™, Intel® HD Graphics 4400/4600
 - Pixel Shader 5.0, DirectX 11.1
 - Max. shared memory 1792MB
 - Three VGA output options: D-Sub, DVI-D and HDMI Ports
 - Supports HDMI Technology with max. resolution up to 1920x1200 @ 60Hz
 - Supports DVI-D with max. resolution up to 1920x1200 @ 60Hz

- Supports D-Sub with max. resolution up to 1920x1200 @ 60Hz
- Supports Auto Lip Sync, Deep Color (12bpc), xvYCC and HBR (High Bit Rate Audio) with HDMI (Compliant HDMI monitor is required)
- Supports HDCP function with DVI-D and HDMI ports
- Supports Full HD 1080p Blu-ray (BD) playback with DVI-D and HDMI ports

Audio

- 7.1 CH HD Audio with Content Protection (Realtek ALC892 Audio Codec)
- Premium Blu-ray audio support

LAN

- PCIE x1 Gigabit LAN 10/100/1000 Mb/s
- Qualcomm® Atheros® AR8171
- Supports Qualcomm® Atheros® Security Wake On Internet Technology
- Supports Wake-On-LAN
- Supports Energy Efficient Ethernet 802.3az
- Supports PXE

Rear Panel I/O

- 1 x PS/2 Mouse/Keyboard Port
- 1 x D-Sub Port
- 1 x DVI-D Port
- 1 x HDMI Port
- 1 x Optical SPDIF Out Port
- 1 x eSATA Connector
- 4 x USB 2.0 Ports
- 2 x USB 3.0 Ports
- 1 x RJ-45 LAN Port with LED (ACT/LINK LED and SPEED LED)
- HD Audio Jack: Rear Speaker / Central / Bass / Line in / Front Speaker / Microphone

- Storage**
- 2 x SATA3 6.0 Gb/s connectors, support NCQ, AHCI and Hot Plug
 - 1 x eSATA connector, supports NCQ, AHCI and Hot Plug

- Connector**
- 1 x Chassis Intrusion header
 - 1 x TPM header
 - 1 x CPU Fan connector (4-pin)
 - 1 x Chassis Fan connector (4-pin)
 - 1 x 24 pin ATX power connector
 - 1 x 4 pin 12V power connector
 - 1 x Front panel audio connector
 - 1 x USB 2.0 header (supports 2 USB 2.0 ports)

- BIOS Feature**
- 32Mb AMI UEFI Legal BIOS with Multilingual GUI support
 - ACPI 1.1 Compliance Wake Up Events
 - SMBIOS 2.3.1 Support
 - CPU, DRAM, PCH 1.05V, PCH 1.5V Voltage Multi-adjustment

- Support CD**
- Drivers, Utilities, AntiVirus Software (Trial Version), CyberLink MediaEspresso 6.5 Trial, Google Chrome Browser and Toolbar, Start8 (30 days trial)

- Hardware Monitor**
- CPU/Chassis Temperature Sensing
 - CPU/Chassis Tachometer
 - CPU/Chassis Quiet Fan (Allow Chassis Fan Speed Auto-Adjust by CPU Temperature)
 - CPU/Chassis Fan Multi-Speed Control
 - CASE OPEN detection
 - Voltage Monitoring: +12V, +5V, +3.3V, CPU Vcore

- OS**
- Microsoft® Windows® 8 / 8 64-bit / 7 / 7 64-bit compliant

- Certifications**
- FCC, CE, WHQL
 - ErP/EuP Ready (ErP/EuP ready power supply is required)

* For detailed product information, please visit our website: <http://www.asrock.com>



Due to limitation, the actual memory size may be less than 4GB for the reservation for system usage under Windows® 32-bit operating systems. Windows® 64-bit operating systems do not have such limitations. You can use ASRock XFast RAM to utilize the memory that Windows® cannot use.

1.3 Unique Features



ASRock A-Tuning

A-Tuning is ASRock's multi purpose software suite with a new interface, more new features and improved utilities, including XFast RAM, Dehumidifier, Good Night LED, FAN-Tastic Tuning, OC Tweaker and a whole lot more.



ASRock Instant Flash

ASRock Instant Flash is a BIOS flash utility embedded in Flash ROM. This convenient BIOS update tool allows you to update the system BIOS in a few clicks without preparing an additional floppy diskette or other complicated flash utility. Just save the new BIOS file to your USB storage and launch this tool by pressing <F6> or <F2> during POST to enter the BIOS setup menu to access ASRock Instant Flash. Please be noted that the USB flash drive or hard drive must use FAT32/16/12 file system.



ASRock APP Charger

Simply by installing the ASRock APP Charger makes your iPhone/iPad/iPod Touch charge up to 40% faster than before on your computer. ASRock APP Charger allows you to quickly charge many Apple devices simultaneously and even supports continuous charging when your PC enters into Standby mode (S1), Suspend to RAM (S3), hibernation mode (S4) or power off (S5).



ASRock XFast USB

ASRock XFast USB can boost the performance of your USB storage devices. The performance may depend on the properties of the device.



ASRock XFast LAN

ASRock XFast LAN provides faster internet access, which includes the benefits listed below. LAN Application Prioritization: You can configure your application's priority ideally and add new programs to the list. Lower Latency in Game: After setting online game's priority higher, it can lower the latency in games. Traffic Shaping: You can watch Youtube HD videos and download simultaneously. Real-Time Analysis of Your Data: With the status window, you can easily recognize which data streams you are currently transferring.



ASRock XFast RAM

ASRock XFast RAM is included in A-Tuning. It fully utilizes the memory space that cannot be used under Windows® 32-bit operating systems. ASRock XFast RAM shortens the loading time of previously visited websites, making web surfing faster than ever. And it also boosts the speed of Adobe Photoshop 5 times faster. Another advantage of ASRock XFast RAM is that it reduces the frequency of accessing your SSDs or HDDs in order to extend their lifespan.



ASRock Crashless BIOS

ASRock Crashless BIOS allows users to update their BIOS without fear of failing. If power loss occurs during the BIOS updating process, ASRock Crashless BIOS will automatically finish the BIOS update procedure after regaining power. Please note that BIOS files need to be placed in the root directory of your USB disk. Only USB 2.0 ports support this feature.



ASRock OMG (Online Management Guard)

Administrators are able to establish an internet curfew or restrict internet access at specified times via OMG. You may schedule the starting and ending hours of internet access granted to other users. In order to prevent users from bypassing OMG, guest accounts without permission to modify the system time are required.



ASRock Internet Flash

ASRock Internet Flash downloads and updates the latest UEFI firmware version from our servers for you without entering Windows® OS. Please setup network configuration before using Internet Flash.



ASRock System Browser

ASRock System Browser shows the overview of your current PC and the devices connected.



ASRock Dehumidifier Function

Users may prevent motherboard damages due to dampness by enabling “Dehumidifier Function”. When enabling Dehumidifier Function, the computer will power on automatically to dehumidify the system after entering S4/S5 state.



ASRock Easy Driver Installer

For users that don't have an optical disk drive to install the drivers from our support CD, Easy Driver Installer is a handy tool in the UEFI that installs the LAN driver to your system via an USB storage device, then downloads and installs the other required drivers automatically.

ASRock Interactive UEFI

ASRock Interactive UEFI is a blend of system configuration tools, cool sound effects and stunning visuals. The unprecedented UEFI provides a more attractive interface and more amusement.

ASRock Fast Boot

With ASRock's exclusive Fast Boot technology, it takes less than 1.5 seconds to logon to Windows 8 from a cold boot. No more waiting! The speedy boot will completely change your user experience and behavior.

ASRock Restart to UEFI

Windows® 8 brings the ultimate boot up experience. The lightning boot up speed makes it hard to access the UEFI setup. ASRock Restart to UEFI allows users to enter the UEFI automatically when turning on the PC. By enabling this function, the PC will enter the UEFI directly after you restart.

ASRock Good Night LED

ASRock Good Night LED technology offers you a better sleeping environment by extinguishing the unessential LEDs. By enabling Good Night LED in the BIOS, the Power/HDD LEDs will be switched off when the system is powered on. Good Night LED will automatically switch off the Power and Keyboard LEDs when the system enters into Standby/Hibernation mode as well.

ASRock USB Key

In a world where time is money, why waste precious time everyday typing usernames to log in to Windows? Why should we even bother memorizing those foot long passwords? Just plug in the USB Key and let your computer log in to windows automatically!

ASRock Home Cloud

This motherboard supports Security Wake On Internet Technology with the onboard Qualcomm® Atheros® LAN, so you can connect with your PC from anywhere in the world. You will be able to power your PC on or turn it off, monitor and take control of it remotely with another smartphone, tablet or computer.

ASRock FAN-Tastic Tuning

ASRock FAN-Tastic Tuning is included in A-Tuning. Configure up to five different fan speeds using the graph. The fans will automatically shift to the next speed level when the assigned temperature is met.

Chapter 2 Installation

This is an Mini-ITX form factor motherboard. Before you install the motherboard, study the configuration of your chassis to ensure that the motherboard fits into it.

Pre-installation Precautions

Take note of the following precautions before you install motherboard components or change any motherboard settings.

- Make sure to unplug the power cord before installing or removing the motherboard. Failure to do so may cause physical injuries to you and damages to motherboard components.
- In order to avoid damage from static electricity to the motherboard's components, NEVER place your motherboard directly on a carpet. Also remember to use a grounded wrist strap or touch a safety grounded object before you handle the components.
- Hold components by the edges and do not touch the ICs.
- Whenever you uninstall any components, place them on a grounded anti-static pad or in the bag that comes with the components.
- When placing screws to secure the motherboard to the chassis, please do not over-tighten the screws! Doing so may damage the motherboard.

2.1 Installing the CPU



1. Before you insert the 1150-Pin CPU into the socket, please check if the **PnP cap** is on the socket, if the CPU surface is unclean, or if there are any **bent pins** in the socket. Do not force to insert the CPU into the socket if above situation is found. Otherwise, the CPU will be seriously damaged.
2. Unplug all power cables before installing the CPU.

1

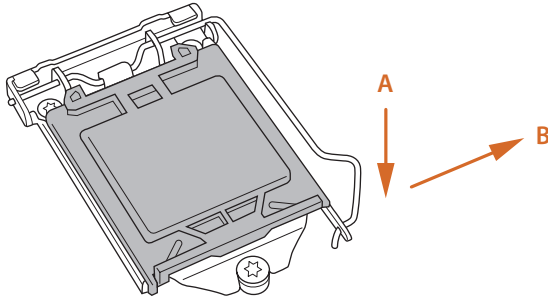

2

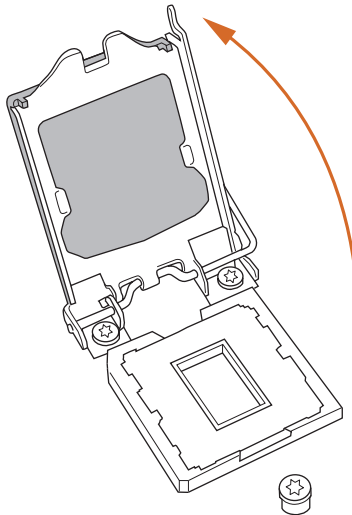

3

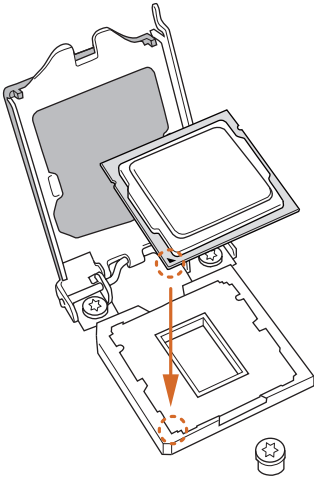

4

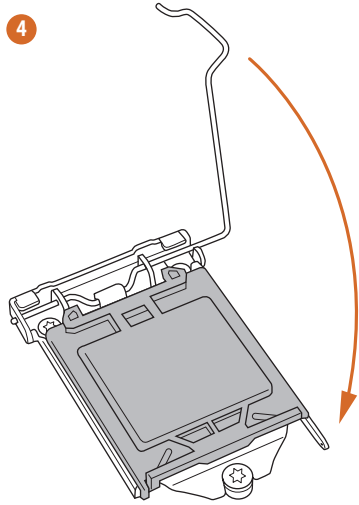

5

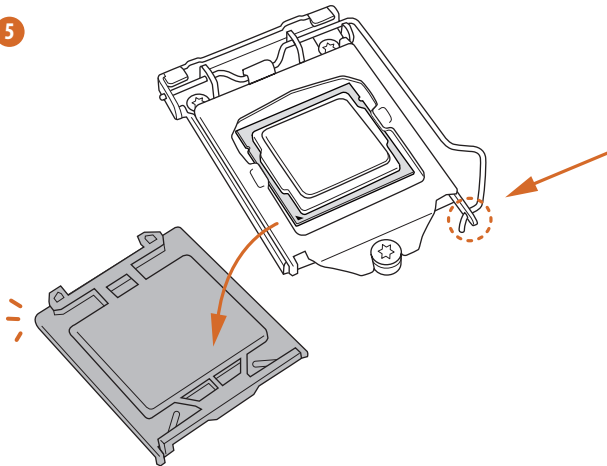



Please save and replace the cover if the processor is removed. The cover must be placed if you wish to return the motherboard for after service.

2.2 Installing the CPU Fan and Heatsink

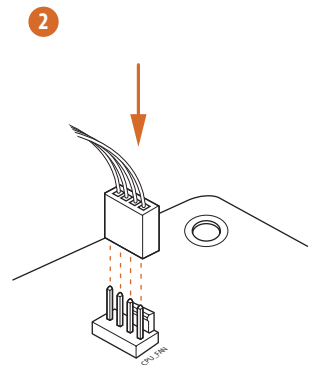
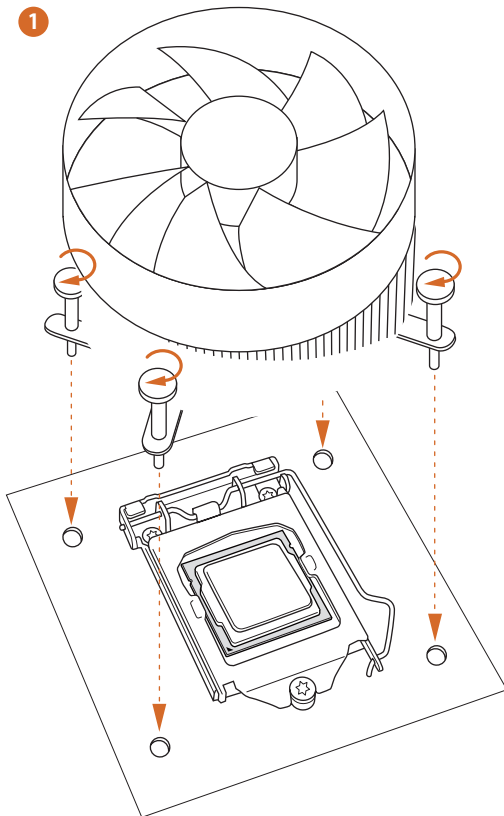
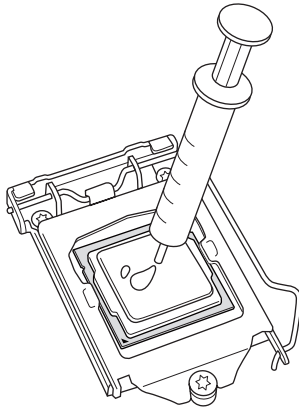

2.3 Installing Memory Modules (DIMM)

This motherboard provides two 240-pin DDR3 (Double Data Rate 3) DIMM slots, and supports Dual Channel Memory Technology.



- 1. For dual channel configuration, you always need to install identical (the same brand, speed, size and chip-type) DDR3 DIMM pairs.*
- 2. It is unable to activate Dual Channel Memory Technology with only one memory module installed.*
- 3. It is not allowed to install a DDR or DDR2 memory module into a DDR3 slot; otherwise, this motherboard and DIMM may be damaged.*



The DIMM only fits in one correct orientation. It will cause permanent damage to the motherboard and the DIMM if you force the DIMM into the slot at incorrect orientation.

1

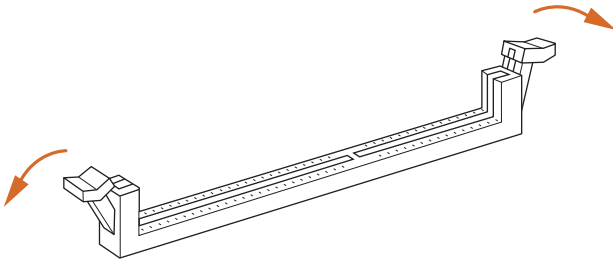

2

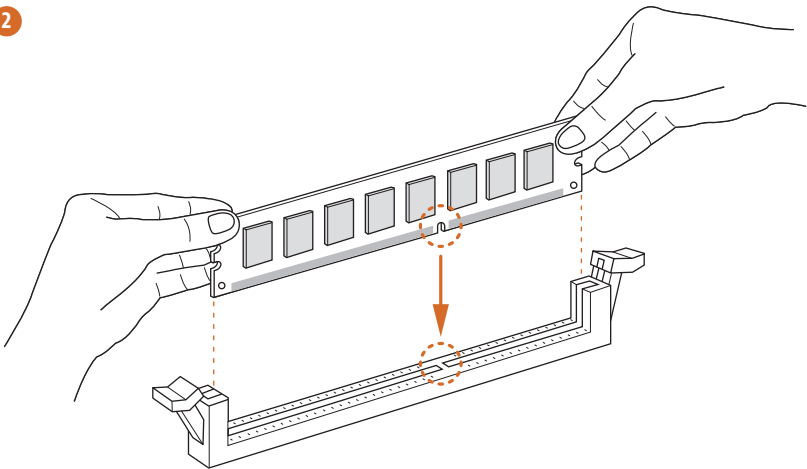

3

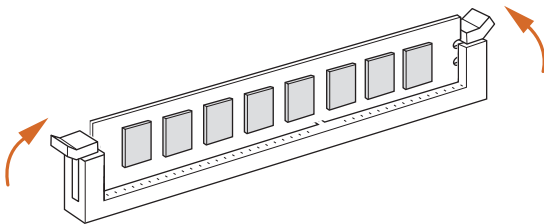

2.4 Expansion Slots (PCI and PCI Express Slots)

There is 1 PCI Express slot on this motherboard.



Before installing an expansion card, please make sure that the power supply is switched off or the power cord is unplugged. Please read the documentation of the expansion card and make necessary hardware settings for the card before you start the installation.

PCIe slots:

PCIe1 (PCIe 2.0 x16 slot) is used for PCI Express x16 lane width graphics cards.

2.5 Jumpers Setup

The illustration shows how jumpers are setup. When the jumper cap is placed on the pins, the jumper is “Short”. If no jumper cap is placed on the pins, the jumper is “Open”. The illustration shows a 3-pin jumper whose pin1 and pin2 are “Short” when a jumper cap is placed on these 2 pins.

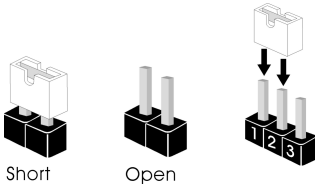

Clear CMOS Jumper
(CLR CMOS1)
(see p.1, No. 3)

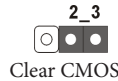

CLR CMOS1 allows you to clear the data in CMOS. To clear and reset the system parameters to default setup, please turn off the computer and unplug the power cord from the power supply. After waiting for 15 seconds, use a jumper cap to short pin2 and pin3 on CLR CMOS1 for 5 seconds. However, please do not clear the CMOS right after you update the BIOS. If you need to clear the CMOS when you just finish updating the BIOS, you must boot up the system first, and then shut it down before you do the clear-CMOS action. Please be noted that the password, date, time, and user default profile will be cleared only if the CMOS battery is removed.



If you clear the CMOS, the case open may be detected. Please adjust the BIOS option “Clear Status” to clear the record of previous chassis intrusion status.

2.6 Onboard Headers and Connectors



Onboard headers and connectors are NOT jumpers. Do NOT place jumper caps over these headers and connectors. Placing jumper caps over the headers and connectors will cause permanent damage to the motherboard.

System Panel Header
(9-pin PANEL1)
(see p.1, No. 8)

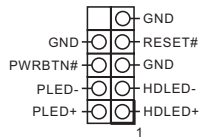

Connect the power switch, reset switch and system status indicator on the chassis to this header according to the pin assignments below. Note the positive and negative pins before connecting the cables.



PWRBTN (Power Switch):

Connect to the power switch on the chassis front panel. You may configure the way to turn off your system using the power switch.

RESET (Reset Switch):

Connect to the reset switch on the chassis front panel. Press the reset switch to restart the computer if the computer freezes and fails to perform a normal restart.

PLED (System Power LED):

Connect to the power status indicator on the chassis front panel. The LED is on when the system is operating. The LED keeps blinking when the system is in S1/S3 sleep state. The LED is off when the system is in S4 sleep state or powered off (S5).

HDLED (Hard Drive Activity LED):

Connect to the hard drive activity LED on the chassis front panel. The LED is on when the hard drive is reading or writing data.

The front panel design may differ by chassis. A front panel module mainly consists of power switch, reset switch, power LED, hard drive activity LED, speaker and etc. When connecting your chassis front panel module to this header, make sure the wire assignments and the pin assignments are matched correctly.

Serial ATA3 Connectors

(SATA3_0:
see p.1, No. 9)
(SATA3_1:
see p.1, No. 10)



These two SATA3 connectors support SATA data cables for internal storage devices with up to 6.0 Gb/s data transfer rate.

USB 2.0 Headers

(9-pin USB10_11)
(see p.1, No. 8)

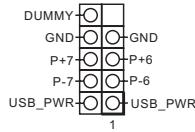

Besides two USB 2.0 ports on the I/O panel, there are one header on this motherboard. Each USB 2.0 header can support two ports.

Front Panel Audio Header

(9-pin HD_AUDIO1)
(see p.1, No. 16)

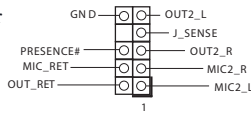

This header is for connecting audio devices to the front audio panel.



1. High Definition Audio supports Jack Sensing, but the panel wire on the chassis must support HDA to function correctly. Please follow the instructions in our manual and chassis manual to install your system.
2. If you use an AC'97 audio panel, please install it to the front panel audio header by the steps below:
 - A. Connect Mic_IN (MIC) to MIC2_L.
 - B. Connect Audio_R (RIN) to OUT2_R and Audio_L (LIN) to OUT2_L.
 - C. Connect Ground (GND) to Ground (GND).
 - D. MIC_RET and OUT_RET are for the HD audio panel only. You don't need to connect them for the AC'97 audio panel.
 - E. To activate the front mic, go to the "FrontMic" Tab in the Realtek Control panel and adjust "Recording Volume".

Chassis Fan Connector
(4-pin CHA_FAN1)
(see p.1, No. 11)

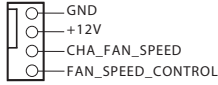

Please connect fan cable to the fan connector and match the black wire to the ground pin.

CPU Fan Connectors
(4-pin CPU_FAN1)
(see p.1, No. 6)

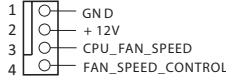

This motherboard provides a 4-Pin CPU fan (Quiet Fan) connector. If you plan to connect a 3-Pin CPU fan, please connect it to Pin 1-3.

ATX Power Connector
(24-pin ATXPWR1)
(see p.1, No. 5)

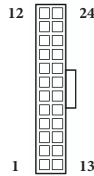

This motherboard provides a 24-pin ATX power connector. To use a 20-pin ATX power supply, please plug it along Pin 1 and Pin 13.

ATX 12V Power Connector
(8-pin ATX12V1)
(see p.1, No. 1)

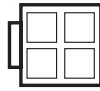

This motherboard provides an 8-pin ATX 12V power connector. To use a 4-pin ATX power supply, please plug it along Pin 1 and Pin 5.

Chassis Intrusion Header
(2-pin CII)
(see p.1, No. 4)



This motherboard supports CASE OPEN detection feature that detects if the chassis cover has been removed. This feature requires a chassis with chassis intrusion detection design.

TPM Header
(17-pin TPMS1)
(see p.1, No. 12)

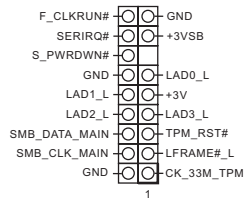

This connector supports Trusted Platform Module (TPM) system, which can securely store keys, digital certificates, passwords, and data. A TPM system also helps enhance network security, protects digital identities, and ensures platform integrity.

1 Einleitung

Vielen Dank, dass Sie sich für das H81M-ITX von ASRock entschieden haben – ein zuverlässiges Motherboard, das konsequent unter der strengen Qualitätskontrolle von ASRock hergestellt wurde. Es liefert ausgezeichnete Leistung mit robustem Design, das ASRocks Streben nach Qualität und Beständigkeit erfüllt.



Da die technischen Daten des Motherboards sowie die BIOS-Software aktualisiert werden können, kann der Inhalt dieser Dokumentation ohne Ankündigung geändert werden.

Falls diese Dokumentation irgendwelchen Änderungen unterliegt, wird die aktualisierte Version ohne weitere Hinweise auf der ASRock-Webseite zur Verfügung gestellt. Sollten Sie technische Hilfe in Bezug auf dieses Motherboard benötigen, erhalten Sie auf unserer Webseite spezifischen Informationen über das von Ihnen verwendete Modell. Auch finden Sie eine aktuelle Liste unterstützter VGA-Karten und Prozessoren auf der ASRock-Webseite: ASRock-Webseite <http://www.asrock.com>.

1.1 Lieferumfang

- ASRock H81M-ITX-Motherboard (Mini-ITX-Formfaktor)
- ASRock H81M-ITX-Schnellinstallationsanleitung
- ASRock H81M-ITX-Support-CD
- 2 x Serial-ATA- (SATA) Datenkabel (optional)
- 1 x E/A-Blendenabschirmung

1.2 Technische Daten

Plattform

- Mini-ITX-Formfaktor
- Vollständig solides Kondensatordesign

Prozessor

- Unterstützt Intel® Core™ i7 / i5 / i3 / Xeon® / Pentium® / Celeron® der 4. Generation im LGA1150-Paket
- 4-Leistungsphasendesign
- Unterstützt Intel® Turbo Boost 2.0-Technologie

Chipsatz

- Intel® H81

Speicher

- Dualkanal-DDR3-Speichertechnologie
- 2 x DDR3-DIMM-Steckplätze
- Unterstützt DDR3 1600/1333/1066 non-ECC, ungepufferter Speicher
- Systemspeicher, max. Kapazität: 16 GB (siehe ACHTUNG)
- Unterstützt Intel® Extreme Memory Profile (XMP)1.3/1.2

Erweiterungssteckplatz

- 1 x PCI-Express 2.0-x16-Steckplatz

Grafikkarte

- Integrierte Intel® HD Graphics-Visualisierung und VGA-Ausgänge können nur mit Prozessoren unterstützt werden, die GPU-integriert sind.
- Unterstützt integrierte Intel® HD Graphics-Visualisierung: Intel® Quick Sync Video mit AVC, MVC (S3D) und MPEG-2 Full HW Encode1, Intel® InTru™ 3D, Intel® Clear Video HD Technology, Intel® Insider™, Intel® HD Graphics 4400/4600
- Pixel Shader 5.0, DirectX 11.1
- Max. geteilter Speicher: 1792 MB
- Drei VGA-Ausgangsoptionen: D-Sub, DVI-D und HDMI
- Unterstützt HDMI-Technologie mit maximaler Auflösung von 1920 x 1200 bei 60 Hz
- Unterstützt DVI-D mit maximaler Auflösung von 1920 x 1200 bei 60 Hz

- Unterstützt D-Sub mit maximaler Auflösung von 1920 x 1200 bei 60 Hz
- Unterstützt Auto-Lippensynchronizität, hohe Farbtiefe (12 bpc), xvYCC und HBR (Audio mit hoher Bitrate) mit HDMI (konformer HDMI-Monitor erforderlich)
- Unterstützt HDCP-Funktion mit DVI-D- und HDMI-Ports
- Unterstützt Blu-ray- (BD) Wiedergabe (Full HD/1080p) mit DVI-D- und HDMI-Ports

Audio

- 7.1-Kanal-HD-Audio mit Inhaltsschutz (Realtek ALC892-Audiocodec)
- Erstklassige Blu-ray-Audiounterstützung

LAN

- PCIE x1 Gigabit LAN 10/100/1000 Mb/s
- Qualcomm® Atheros® AR8171
- Unterstützt Qualcomm® Atheros® Security Wake On Internet-Technologie
- Unterstützt Wake-On-LAN
- Unterstützt energieeffizientes Ethernet 802.3az
- Unterstützt PXE

Rückblende, E/A

- 1 x PS/2-Mausanschluss/Tastaturanschluss
- 1 x D-Sub-Port
- 1 x DVI-D-Port
- 1 x HDMI-Port
- 1 x Optischer SPDIF-Ausgang
- 1 x eSATA-Anschluss
- 4 x USB 2.0-Ports
- 2 x USB 3.0-Ports
- 1 x RJ-45-LAN-Port mit LED (Aktivität/Verbindung-LED und Geschwindigkeit-LED)
- HD-Audioanschluss: Hintere Lautsprecher / Zentral / Bass / Line-in / Vorderer Lautsprecher / Mikrofon

Speicher

- 2 x SATA-III-6,0-Gb/s-Anschlüsse, unterstützt NCQ, AHCI und Hot-Plugging
- 1 x eSATA-Anschluss, unterstützt NCQ, AHCI und Hot-Plugging

Anschluss

- 1 x Gehäuseeingriff-Stiftleiste
- 1 x TPM-Stiftleiste
- 1 x CPU-Lüfteranschluss (4-polig)
- 1 x Gehäuselüfteranschluss (4-polig)
- 1 x 24-poliger ATX-Netzanschluss
- 1 x 4-poliger 12-V-Netzanschluss
- 1 x Audioanschluss an Frontblende
- 1 x USB 2.0-Stiftleiste (unterstützt zwei USB 2.0-Ports)

BIOS-Funktion

- 32-Mb-AMI-UEFI-Legal-BIOS mit Unterstützung mehrsprachiger grafischer Benutzerschnittstellen
- ACPI 1.1-konforme Aufweckereignisse
- SMBIOS 2.3.1-Unterstützung
- CPU, DRAM, PCH 1,05 V, PCH 1,5 V / Mehrfachspannungsanpassung

Support-CD

- Treiber, Dienstprogramme, Antivirensoftware (Testversion), CyberLink MediaEspresso 6.5-Testversion, Google Chrome Browser und Toolbar, Start8 (30-Tage-Testversion)

Hardwareüberwachung

- CPU-/Gehäusetemperaturerkennung
- CPU-/Gehäusetachometer
- Lautloser CPU-/Gehäuselüfter (ermöglicht automatische Anpassung der Geschwindigkeit des Gehäuselüfters über die CPU-Temperatur)
- CPU/Gehäuselüfter-Mehrfachgeschwindigkeitssteuerung
- Gehäuse-offen-Erkennung
- Spannungsüberwachung: +12 V, +5 V, +3,3 V, CPU Vcore

Betriebssystem

- Konform mit Microsoft® Windows® 8 / 8, 64 Bit / 7 / 7, 64 Bit

Zertifizierungen

- FCC, CE, WHQL
- ErP/EuP ready (ErP/EuP ready-Netzteil erforderlich)

* Detaillierte Produktinformationen finden Sie auf unserer Webseite: <http://www.asrock.com>



Aufgrund von Beschränkungen kann die Größe des tatsächlich für die Systemnutzung reservierten Speichers unter Windows®-Betriebssystemen mit 32 Bit weniger als 4 GB betragen. Windows®-Betriebssysteme mit 64 Bit haben keine derartigen Beschränkungen. Mit ASRock XFast RAM können Sie den Speicher einsetzen, den Windows® nicht nutzen kann.

1.3 JumperEinstellung

Die Abbildung zeigt, wie die Jumper eingestellt werden. Wenn die Jumper-Kappe auf den Kontakten angebracht ist, ist der Jumper „kurzgeschlossen“. Wenn keine Jumper-Kappe auf den Kontakten angebracht ist, ist der Jumper „offen“. Die Abbildung zeigt einen 3-poligen Jumper, dessen Kontakt 1 und Kontakt 2 „kurzgeschlossen“ sind, wenn eine Jumper-Kappe auf diesen 2 Kontakten angebracht ist.

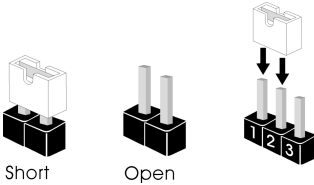

CMOS-löschen-Jumper
(CLRCMOS1)
(siehe S. 1, Nr. 3)

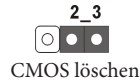

CLRCMOS1 ermöglicht Ihnen die Löschung der Daten im CMOS. Zum Löschen und Zurücksetzen der Systemparameter auf die Standardeinrichtung schalten Sie den Computer bitte ab und ziehen das Netzkabel aus der Steckdose. Warten Sie 15 Sekunde, schließen Sie dann Kontakt 2 und Kontakt 3 an CLRCMOS1 5 Sekunden lang mit einer Jumper-Kappe kurz. Löschen Sie den CMOS jedoch nicht direkt nach der BIOS-Aktualisierung. Falls Sie den CMOS direkt nach Abschluss der BIOS-Aktualisierung löschen müssen, starten Sie das System zunächst; fahren Sie es dann vor der CMOS-Löschung herunter. Bitte beachten Sie, dass Kennwort, Datum, Zeit und Benutzerstandardprofil nur gelöscht werden, wenn die CMOS-Batterie entfernt wird.



Falls Sie den CMOS löschen, wird möglicherweise ein Gehäuseeingriff erkannt. Bitte passen Sie die BIOS-Option „Status löschen“ zur Löschung der Aufzeichnung des vorherigen Gehäuseeingriffstatus an.

1.4 Integrierte Stiftleisten und Anschlüsse



Integrierte Stiftleisten und Anschlüsse sind KEINE Jumper. Bringen Sie KEINE Jumper-Kappen an diesen Stiftleisten und Anschlüssen an. Durch Anbringen von Jumper-Kappen an diesen Stiftleisten und Anschlüssen können Sie das Motherboard dauerhaft beschädigen.

Systemblende-Stiftleiste
(9-polig, PANEL1)
(siehe S. 1, Nr. 8)

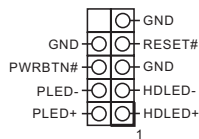

Verbinden Sie Netzschalter, Reset-Taste und Systemstatusanzeige am Gehäuse entsprechend der nachstehenden Pinbelegung mit dieser Stiftleiste. Beachten Sie vor Anschließen der Kabel die positiven und negativen Kontakte.



PWRBTN (Ein-/Austaste):

Mit der Ein-/Austaste an der Frontblende des Gehäuses verbinden. Sie können die Abschaltung Ihres Systems über die Ein-/Austaste konfigurieren.

RESET (Reset-Taste):

Mit der Reset-Taste an der Frontblende des Gehäuses verbinden. Starten Sie den Computer über die Reset-Taste neu, wenn er abstürzt oder sich nicht normal neu starten lässt.

PLED (Systembetriebs-LED):

Mit der Betriebsstatusanzeige an der Frontblende des Gehäuses verbinden. Die LED leuchtet, wenn das System läuft. Die LED blinkt, wenn sich das System im S1/S3-Ruhezustand befindet. Die LED ist aus, wenn sich das System im S4-Ruhezustand befindet oder ausgeschaltet ist (S5).

HDLED (Festplattenaktivitäts-LED):

Mit der Festplattenaktivitäts-LED an der Frontblende des Gehäuses verbinden. Die LED leuchtet, wenn die Festplatte Daten liest oder schreibt.

Das Design der Frontblende kann je nach Gehäuse variieren. Ein Frontblendenmodul besteht hauptsächlich aus Ein-/Austaste, Reset-Taste, Betrieb-LED, Festplattenaktivitäts-LED, Lautsprecher etc. Stellen Sie beim Anschließen Ihres Frontblendenmoduls an diese Stiftleiste sicher, dass Kabel- und Pinbelegung richtig abgestimmt sind.

Serial-ATA-III-Anschlüsse

(SATA3_0:
siehe S. 1, Nr. 9)
(SATA3_1:
siehe S. 1, Nr. 10)



Diese zwei SATA-III-Anschlüsse unterstützen SATA-Datenkabel für interne Speichergeräte mit einer Datenübertragungsgeschwindigkeit bis 6,0 Gb/s.

USB 2.0-Stiftleisten
(9-polig, USB10_11)
(siehe S. 1, Nr. 8)

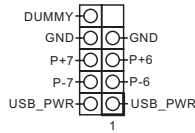

Neben zwei USB 2.0-Ports an der E/A-Blende befindet sich eine Stiftleiste an diesem Motherboard. Jede USB 2.0-Stiftleiste kann zwei Ports unterstützen.

Audiostiftleiste
(Frontblende)
(9-polig, HD_AUDIO1)
(siehe S. 1, Nr. 16)

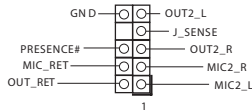

Diese Stiftleiste dient dem Anschließen von Audiogeräten an der Frontblende.



1. High Definition Audio unterstützt Anschlusserkennung, der Draht am Gehäuse muss dazu jedoch HDA unterstützen. Bitte befolgen Sie zum Installieren Ihres Systems die Anweisungen in unserer Anleitung und der Anleitung zum Gehäuse.
2. Bei Nutzung eines AC'97-Audiopanel dieses bitte anhand folgender Schritte an der Audiostiftleiste der Frontblende installieren:
 - A. Mic_IN (Mikrofon) mit MIC2_L verbinden.
 - B. Audio_R (RIN) mit OUT2_R und Audio_L (LIN) mit OUT2_L verbinden.
 - C. Erde (GND) mit Erde (GND) verbinden.
 - D. MIC_RET und OUT_RET sind nur für das HD-Audiopanel vorgesehen. Sie müssen sie nicht für das AC'97-Audiopanel verbinden.
 - E. Rufen Sie zum Aktivieren des vorderen Mikrofons das „FrontMic (Vorderes Mikrofon)“-Register in der Realtek-Systemsteuerung auf und passen „Recording Volume (Aufnahmelautstärke)“ an.

Gehäuselüfteranschluss
(4-polig, CHA_FAN1)
(siehe S. 1, Nr. 11)

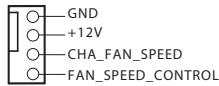

Bitte verbinden Sie das Lüfterkabel mit dem Lüfteranschluss; der schwarze Draht gehört zum Erdungskontakt.

CPU-Lüfteranschlüsse
(4-polig, CPU_FAN1)
(siehe S. 1, Nr. 6)

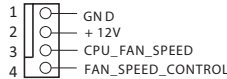

Dieses Motherboard bietet einen 4-poligen CPU-Lüfteranschluss (lautloser Lüfter). Falls Sie einen 3-poligen CPU-Lüfter anschließen möchten, verbinden Sie ihn bitte mit Kontakt 1 bis 3.

ATX-Netzanschluss
(24-polig, ATXPWR1)
(siehe S. 1, Nr. 5)

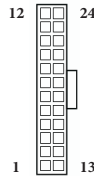

Dieses Motherboard bietet einen 24-poligen ATX-Netzanschluss. Bitte schließen Sie es zur Nutzung eines 20-poligen ATX-Netzteils entlang Kontakt 1 und Kontakt 13 an.

ATX-12-V-Netzanschluss
(8-polig, ATX12V1)
(siehe S. 1, Nr. 1)



Dieses Motherboard bietet einen 8-poligen ATX-12-V-Netzanschluss. Bitte schließen Sie es zur Nutzung eines 4-poligen ATX-Netzteils entlang Kontakt 1 und Kontakt 5 an.

Gehäuseeingriff-
Stiftleiste(2-polig, CII)
(siehe S. 1, Nr. 4)

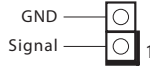

Dieses Motherboard unterstützt die Gehäuse-offen-Erkennung, die erkennt, wenn die Gehäuseabdeckung entfernt wurde. Diese Funktion setzt ein Gehäuse mit Gehäuseeingriffserkennungsdesign voraus.

TPM-Stiftleiste
(17-polig, TPMS1)
(siehe S. 1, Nr. 12)

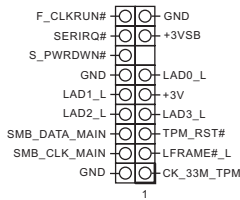

Dieser Anschluss unterstützt das Trusted Platform Module- (TPM) System, das Schlüssel, digitale Zertifikate, Kennwörter und Daten sicher aufbewahren kann. Ein TPM-System hilft zudem bei der Stärkung der Netzwerksicherheit, schützt digitale Identitäten und gewährleistet die Plattformintegrität.

1 Introduction

Nous vous remercions d'avoir acheté cette carte mère ASRock H81M-ITX, une carte mère fiable fabriquée conformément au contrôle de qualité rigoureux et constant appliqué par ASRock. Elle vous offre de performances élevées associées à une conception robuste, dignes de l'engagement de qualité et de durabilité qui font la réputation de ASRock.



Les spécifications de la carte mère et du logiciel BIOS pouvant être mises à jour, le contenu de ce document est soumis à modification sans préavis. En cas de modifications du présent document, la version mise à jour sera disponible sur le site Internet ASRock sans notification préalable. Si vous avez besoin d'une assistance technique pour votre carte mère, veuillez visiter notre site Internet pour plus de détails sur le modèle que vous utilisez. La liste la plus récente des cartes VGA et des processeurs pris en charge est également disponible sur le site Internet de ASRock. Site Internet ASRock <http://www.asrock.com>.

1.1 Contenu de l'emballage

- Carte mère ASRock H81M-ITX (facteur de forme Mini-ITX)
- Guide d'installation rapide ASRock H81M-ITX
- CD d'assistance ASRock H81M-ITX
- 2 x câbles de données Serial ATA (SATA) (Optionnel)
- 1 x panneau de protection E/S

1.2 Spécifications

- Plateforme**
- Facteur de forme Mini-ITX
 - Conception à condensateurs solides

- Processeur**
- Prend en charge les processeurs de 4^{ème} Génération Intel® Core™ i7 / i5 / i3 / Xeon® / Pentium® / Celeron® en package LGA1150
 - Alimentation à 4 phases
 - Prend en charge la technologie Intel® Turbo Boost 2.0

- Chipset**
- Intel® H81

- Mémoire**
- Technologie mémoire double canal DDR3
 - 2 x fentes DIMM DDR3
 - Prend en charge les mémoires sans tampon non ECC DDR3 1600/1333/1066
 - Capacité max. de la mémoire système : 16Go (voir AVERTISSEMENT)
 - Prend en charge Intel® Extreme Memory Profile (XMP)1.3/1.2

- Fente d'expansion**
- 1 x fente PCI Express 2.0 x16

- Graphiques**
- La technologie Intel® HD Graphics Built-in Visuals et les sorties VGA sont uniquement prises en charge par les processeurs intégrant un contrôleur graphique.
 - Prend en charge la technologie Intel® HD Graphics Built-in Visuals : Intel® Quick Sync Video avec AVC, MVC (S3D) et MPEG-2 Full HW Encode1, Intel® InTru™ 3D, technologie Intel® Clear Video HD, Intel® Insider™, Intel® HD Graphics 4400/4600
 - Pixel Shader 5.0, DirectX 11.1
 - Mémoire partagée max. 1792Mo
 - Trois options de sortie VGA : D-Sub, DVI-D et HDMI
 - Prend en charge la technologie HDMI avec une résolution maximale de 1920x1200 @ 60Hz
 - Prend en charge le mode DVI-D avec une résolution maximale de 1920x1200 @ 60Hz

- Prend en charge le mode D-Sub avec une résolution maximale de 1920x1200 @ 60Hz
- Prend en charge les technologies Auto Lip Sync, Deep Color (12bpc), xvYCC et HBR (High Bit Rate Audio) avec HDMI (un écran compatible HDMI est requis)
- Prend en charge la fonction HDCP via ports DVI-D et HDMI
- Prend en charge la lecture Blu-ray (BD) Full HD 1080p via ports DVI-D et HDMI

Audio

- Audio 7.1 CH HD avec protection du contenu (codec audio Realtek ALC892)
- Compatible audio Blu-ray Premium

Réseau

- PCIE x1 Gigabit LAN 10/100/1000 Mo/s
- Qualcomm® Atheros® AR8171
- Prend en charge la technologie Qualcomm® Atheros® Security Wake On sur Internet
- Prend en charge la fonction Wake-On-LAN
- Prend en charge la fonction d'économie d'énergie Ethernet 802.3az
- Prend en charge PXE

Connectique du panneau arrière

- 1 x port clavier/souris PS/2
- 1 x port D-Sub
- 1 x port DVI-D
- 1 x port HDMI
- 1 x port sortie optique SPDIF
- 1 x connecteur eSATA
- 4 x ports USB 2.0
- 2 x ports USB 3.0
- 1 x port RJ-45 LAN avec LED (LED ACT/LIEN et LED VITESSE)
- Connecteurs jack audio HD : Haut-parleur arrière / central / basses / entrée ligne / haut-parleur avant / microphone

Stockage

- 2 x connecteurs SATA3 6,0 Go/s, compatible avec les fonctions NCQ, AHCI et Hot Plug
- 1 x connecteur eSATA, compatible avec les fonctions NCQ, AHCI et Hot Plug

Connectique

- 1 x embase d'intrusion châssis
- 1 x embase TPM
- 1 x connecteur pour ventilateur de CPU (4 broches)
- 1 x connecteur pour ventilateur de châssis (4 broches)
- 1 x connecteur d'alimentation ATX 24 broches
- 1 x connecteur d'alimentation 12V 4 broches
- 1 x connecteur audio panneau frontal
- 1 x embase USB 2.0 (pour 2 ports USB 2.0)
- 1 x embase USB 3.0 (pour 2 ports USB 3.0)

BIOS

- BIOS UEFI AMI 32Mo avec prise en charge d'interface graphique multilingue
- Compatible ACPI 1.1 Wake Up Events
- Prend en charge SMBIOS 2.3.1
- Réglage de la tension CPU, DRAM, PCH 1,05V, PCH 1,5V

CD inclus

- Pilotes, utilitaires, logiciel AntiVirus (version d'évaluation), version d'essai CyberLink MediaEspresso 6.5, navigateur Google Chrome et barre d'outils, Start8 (30 jours d'évaluation)

Surveillance du matériel

- Détection de la température du processeur/châssis
- Tachéomètre processeur/châssis
- Fonction ventilateur silencieux processeur/châssis Quiet Fan (permet au ventilateur du châssis d'adapter sa vitesse de rotation automatiquement en fonction de la température du processeur)
- Contrôle simultané des vitesse du ventilateur processeur/châssis
- Détection CHASSIS OUVERT
- Surveillance de la tension d'alimentation : +12V, +5V, +3,3V, CPU Vcore

Système d'exploitation

- Compatible Microsoft® Windows® 8 / 8 64-bit / 7 / 7 64-bits

Certifications

- FCC, CE, WHQL
- ErP/EuP Ready (alimentation ErP/EuP ready require)

* pour des informations détaillées de nos produits, veuillez visiter notre site : <http://www.asrock.com>



En raison de limitations dues au système d'exploitation, la capacité de mémoire utilisée sous Windows® 32-bit peut être inférieure à 4 Go. Cette limitation ne concerne pas les systèmes d'exploitation Windows® 64-bit. Vous pouvez utiliser ASRock XFast RAM pour utiliser la mémoire dont Windows® ne peut se servir.

1.3 Configuration des cavaliers (jumpers)

L'illustration ci-dessous vous renseigne sur la configuration des cavaliers (jumpers). Lorsque le capuchon du cavalier est installé sur les broches, le cavalier est 'court-circuité'. Si le capuchon du cavalier n'est pas installé sur les broches, le cavalier est 'ouvert'. L'illustration représente un cavalier à 3 broches dont les broches 1 et 2 sont « court-circuitées » si un capuchon de cavalier est posé sur ces 2 broches.

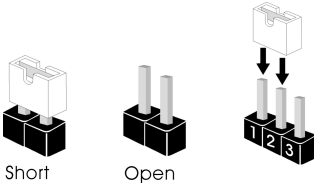

Cavalier Clear CMOS
(CLRCMOS1)
(voir p.1, No. 3)



Par défaut



Fonction Clear CMOS

CLRCMOS1 vous permet d'effacer les données de la CMOS. Pour effacer les paramètres du système et rétablir les valeurs par défaut, veuillez éteindre votre ordinateur et débrancher son cordon d'alimentation. Patientez 15 secondes, puis utilisez un capuchon de cavalier pour court-circuiter la broche 2 et la broche 3 sur CLRCMOS1 pendant 5 secondes. Toutefois, n'effacez pas la CMOS immédiatement après avoir mis à jour le BIOS. Si vous avez besoin d'effacer les données CMOS après une mise à jour du BIOS, vous devez tout d'abord redémarrer le système, puis l'éteindre avant de procéder à l'effacement de la CMOS. Veuillez noter que les paramètres mot de passe, date, heure et profil par défaut de l'utilisateur seront uniquement effacés en cas de retrait de la pile de la CMOS.



Si vous effacez la CMOS, l'alerte de châssis ouvert peut se déclencher. Veuillez régler l'option du BIOS sur « Effacer » pour supprimer l'historique des intrusions de châssis précédentes.

1.4 Embases et connecteurs de la carte mère



Les embases et connecteurs situés sur la carte NE SONT PAS des cavaliers. Ne placez JAMAIS de capuchons de cavaliers sur ces embases ou connecteurs. Placer un capuchon de cavalier sur ces embases ou connecteurs endommagera irrémédiablement votre carte mère.

Embase du panneau système
(PANNEAU1 à 9 broches)
(voir p.1, No. 8)

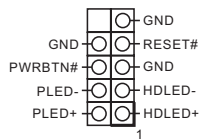

Branchez le bouton de mise en marche/arrêt, le bouton de réinitialisation et le témoin d'état du système présents sur le châssis sur cette embase en respectant la configuration des broches illustrée ci-dessous. Repérez les broches positive et négative avant de brancher les câbles.



PWRBTN (bouton d'alimentation):

pour brancher le bouton d'alimentation du panneau frontal du châssis. Vous pouvez configurer la façon dont votre système doit s'arrêter à l'aide du bouton de mise en marche.

RESET (bouton de réinitialisation):

pour brancher le bouton de réinitialisation du panneau frontal du châssis. Appuyez sur le bouton de réinitialisation pour redémarrer l'ordinateur en cas de plantage ou de dysfonctionnement au démarrage.

PLED (LED d'alimentation du système) :

pour brancher le témoin d'état de l'alimentation du panneau frontal du châssis. Le LED est allumé lorsque le système fonctionne. Le LED clignote lorsque le système se trouve en mode veille S1/S3. Le LED est éteint lorsque le système se trouve en mode veille S4 ou hors tension (S5).

HDLED (LED d'activité du disque dur) :

pour brancher le témoin LED d'activité du disque dur du panneau frontal du châssis. Le LED est allumé lorsque le disque dur lit ou écrit des données.

La conception du panneau frontal peut varier en fonction du châssis. Un module de panneau frontal est principalement composé d'un bouton de mise en marche, bouton de réinitialisation, LED d'alimentation, LED d'activité du disque dur, haut-parleur etc. Lorsque vous reliez le module du panneau frontal de votre châssis sur cette embase, veillez à parfaitement faire correspondre les fils et les broches.

Connecteurs Serial ATA3

(SATA3_0:
voir p.1, No. 9)
(SATA3_1:
voir p.1, No. 10)



Ces deux connecteurs SATA3 sont compatibles avec les câbles de données SATA pour les appareils de stockage internes avec un taux de transfert maximal de 6,0 Go/s.

Embases USB 2,0
(USB10_11 à 9 broches)
(voir p.1, No. 8)

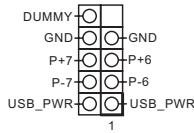

En plus des deux ports USB 2.0 sur le panneau E/S, cette carte mère est dotée d'une embase supplémentaire. Chaque embase USB 2.0 peut prendre en charge deux ports.

Embase audio du panneau frontal
(HD_AUDIO1 à 9 broches)
(voir p.1, No. 16)

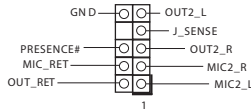

Cette embase sert au branchement des appareils audio au panneau audio frontal.



- L'audio haute définition prend en charge la technologie Jack Sensing (détection de la fiche), mais le panneau grillagé du châssis doit être compatible avec la HDA pour fonctionner correctement. Veuillez suivre les instructions figurant dans notre manuel et dans le manuel du châssis pour installer votre système.
- Si vous utilisez un panneau audio AC'97, veuillez le brancher sur l'embase audio du panneau frontal en procédant comme suit :
 - branchez Mic_IN (MIC) sur MIC2_L.
 - branchez Audio_R (RIN) sur OUT2_R et Audio_L (LIN) sur OUT2_L.
 - branchez la mise à terre (GND) sur mise à terre (GND).
 - MIC_RET et OUT_RET sont exclusivement réservés au panneau audio HD. Il est inutile de les brancher avec le panneau audio AC'97.
 - Pour activer le micro frontal, sélectionnez l'onglet « FrontMic » du panneau de contrôle Realtek et réglez le paramètre « Volume d'enregistrement ».

Connecteur du ventilateur
du châssis
(CHA_FAN1 à 4 broches)
(voir p.1, No. 11)

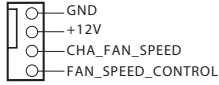

Veillez brancher les câbles du ventilateur sur le connecteur du ventilateur, puis reliez le fil noir à la broche de mise à terre.

Connecteurs du ventilateur du processeur
(CPU_FAN1 à 4 broches)
(voir p.1, No. 6)

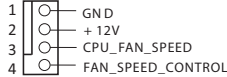

Cette carte mère est dotée d'un connecteur à 4 broches pour ventilateur de processeur (Quiet Fan). Si vous envisagez de connecter un ventilateur de processeur à 3 broches, veuillez le brancher sur la Broche 1-3.

Connecteur d'alimentation
ATX
(ATXPWR1 à 24 broches)
(voir p.1, No. 5)

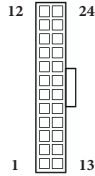

Cette carte mère est dotée d'un connecteur d'alimentation ATX à 24 broches. Pour utiliser une alimentation ATX à 20 broches, veuillez effectuer les branchements sur la Broche 1 et la Broche 13.

Connecteur d'alimentation
ATX 12V
(ATX12V1 à 8 broches)
(voir p.1, No. 1)



Cette carte mère est dotée d'un connecteur d'alimentation ATX 12V à 8 broches. Pour utiliser une alimentation ATX à 4 broches, veuillez effectuer les branchements sur la Broche 1 et la Broche 5.

Embase d'intrusion
 châssis(CII à 2 broches)
 (voir p.1, No. 4)

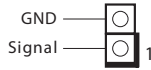

Cette carte mère prend en charge la fonction de détection CHASSIS OUVERT qui alerte l'utilisateur en cas de retrait du boîtier du châssis. Cette fonction requiert un châssis à conception intégrant la détection d'intrusion.

Embase TPM
 (TPMS1 à 17 broches)
 (voir p.1, No. 12)

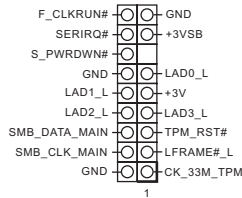

Ce connecteur prend en charge un module TPM (Trusted Platform Module – Module de plateforme sécurisée), qui permet de sauvegarder clés, certificats numériques, mots de passe et données en toute sécurité. Le système TPM permet également de renforcer la sécurité du réseau, de protéger les identités numériques et de préserver l'intégrité de la plateforme.

1 Introduzione

Grazie per aver acquistato la scheda madre H81M-ITX ASRock, una scheda madre affidabile prodotta secondo i costanti e rigorosi controlli di qualità di ASRock.

La scheda madre offre eccellenti prestazioni con un design robusto che si adatta all'impegno di ASRock di offrire sempre qualità e durata.



Dato che le specifiche della scheda madre e del software BIOS possono essere aggiornate, il contenuto di questa documentazione sarà soggetto a variazioni senza preavviso. Nel caso di eventuali modifiche della presente documentazione, la versione aggiornata sarà disponibile sul sito Web di ASRock senza ulteriore preavviso. Per il supporto tecnico correlato a questa scheda madre, visitare il nostro sito Web per informazioni specifiche relative al modello attualmente in uso. È possibile trovare l'elenco di schede VGA più recenti e di supporto di CPU anche sul sito Web di ASRock. Sito Web di ASRock <http://www.asrock.com>.

1.1 Contenuto della confezione

- Scheda madre H81M-ITX ASRock (fattore di forma Mini-ITX)
- Guida rapida di installazione H81M-ITX ASRock
- CD di supporto H81M-ITX ASRock
- 2 x cavi dati Serial ATA (SATA) (opzionali)
- 1 x mascherina metallica posteriore I/O

1.2 Specifiche

- Piattaforma**
- Fattore di forma Mini-ITX
 - Design di condensatore solido

- CPU**
- Supporta Intel® Core™ i7 / i5 / i3 di 4ª generazione / Xeon® / Pentium® / Celeron® in LGA1150 Package
 - 4 Power Phase Design
 - Supporta la tecnologia Intel® Turbo Boost 2.0

- Chipset**
- Intel® H81

- Memoria**
- Tecnologia con memoria DDR3 a doppio canale
 - 2 x slot DIMM DDR3
 - Supporta la memoria DDR3 1600/1333/1066 non ECC, senza buffer
 - Capacità max. della memoria di sistema: 16 GB (si veda la sezione ATTENZIONE)
 - Supporta Intel® Extreme Memory Profile (XMP) 1.3/1.2

- Slot di espansione**
- 1 x PCI Express 2.0 x16 slot

- Grafica**
- La videografica integrata della scheda video HD Intel® e le uscite VGA possono essere supportate soltanto con processori con GPU integrata.
 - Supporta la videografica integrata della scheda video HD Intel®: Intel® Quick Sync Video con AVC, MVC (S3D) e MPEG-2 Full HW Encode1, Intel® InTru™ 3D, tecnologia Intel® Clear Video HD, Intel® Insider™, Intel® HD Graphics 4400/4600
 - Pixel Shader 5.0, DirectX 11.1
 - Memoria condivisa max. 1792 MB
 - Tre opzioni uscita VGA: D-Sub, DVI-D e HDMI
 - Supporta la tecnologia HDMI con una risoluzione max. fino a 1920 x 1200 a 60 Hz
 - Supporta DVI-D con una risoluzione max. fino a 1920 x 1200 a 60 Hz

- Supporta D-Sub con una risoluzione max. fino a 1920 x 1200 a 60 Hz
- Supporta Auto Lip Sync, Deep Color (12 bpc), xvYCC e HBR (High Bit Rate Audio) con HDMI (è necessario un monitor conforme ad HDMI)
- Supporta la funzione HDCP con porte DVI-D e HDMI
- Supporta Blu-ray (BD) Full HD 1080p, riproduzione con porte DVI-D e HDMI

Audio

- Audio HD a 7.1 canali con Content Protection (codec audio Realtek ALC892)
- Supporto audio Blu-ray Premium

LAN

- PCIE x 1 LAN Gigabit 10/100/1000 Mb/s
- Qualcomm® Atheros® AR8171
- Supporta la tecnologia Qualcomm® Atheros® Security Wake On Internet
- Supporta Wake-On-LAN
- Supporta Energy Efficient Ethernet 802.3az
- Supporta PXE

I/O pannello posteriore

- 1 x porta PS/2 per mouse/tastiera
- 1 x porta D-Sub
- 1 x porta DVI-D
- 1 x porta HDMI
- 1 x porta uscita SPDIF ottico
- 1 x connettore eSATA
- 4 x porte USB 2.0
- 2 x porte USB 3.0
- 1 x porta LAN RJ-45 con LED (ACT/LINK LED e SPEED LED)
- Jack audio HD: altoparlante posteriore/centrale/basso/ingresso linea/altoparlante anteriore/microfono

- Archiviazione**
- 2 x connettori SATA3 6,0 Gb/s, supporta le funzioni NCQ, AHCI e Hot Plug
 - 1 x connettore eSATA, supporta le funzioni NCQ, AHCI e Hot Plug

- Connettore**
- 1 x header di intrusione nello chassis
 - 1 x header TPM
 - 1 x connettore ventola CPU (4 pin)
 - 1 x connettore ventola chassis (4 pin)
 - 1 x connettore alimentazione ATX a 24 pin
 - 1 x connettore alimentazione da 12 V a 4 pin
 - 1 x connettore audio pannello anteriore
 - 1 x header USB 2.0 (supporta 2 porte USB 2.0)

- Caratteristiche del BIOS**
- BIOS legale 32 Mb AMI UEFI con supporto GUI multilingue
 - Eventi di wake up conformi ad ACPI 1.1
 - Supporto SMBIOS 2.3.1
 - Multiregolazione tensione CPU, DRAM, PCH 1,05 V, PCH 1,5 V

- CD di supporto**
- Driver, Utilità, software antivirus (versione di prova), versione di prova di CyberLink MediaEspresso 6.5, browser e barra degli strumenti Google Chrome, Start8 (30 giorni di prova)

- Hardware Monitor**
- Sensore temperatura CPU/chassis
 - Tachimetro CPU/chassis
 - Ventola silenziosa CPU/chassis (consente l'autoregolazione della velocità della ventola dello chassis mediante la temperatura della CPU)
 - Controllo multivelocità della ventola di CPU/chassis
 - Rilevamento CASE OPEN
 - Monitoraggio tensione: +12 V, +5 V, +3,3 V, CPU Vcore

- SO**
- Microsoft® Windows® 8/8 a 64-bit/7/conforme a 7 a 64-bit

- Certificazioni**
- FCC, CE, WHQL
 - ErP/EuP Ready (è necessaria alimentazione ErP/EuP ready)

* Per informazioni dettagliate sul prodotto, visitare il nostro sito Web: <http://www.asrock.com>



A causa della limitazione, l'effettiva dimensione della memoria può essere inferiore a 4 GB per riservare l'uso del sistema ai sistemi operativi di Windows® a 32 bit. I sistemi operativi Windows® a 64 bit non possiedono tali limitazioni. È possibile utilizzare la RAM XFast di ASRock per utilizzare la memoria che Windows® non può utilizzare.

1.3 Impostazione jumper

L'illustrazione mostra in che modo vengono impostati i jumper. Quando il cappuccio del jumper è posizionato sui pin, il jumper è "cortocircuitato". Se sui pin non è posizionato alcun cappuccio del jumper, il jumper è "aperto". L'illustrazione mostra un jumper a 3 pin i cui pin1 e pin2 sono "cortocircuitati" quando un cappuccio del jumper è posizionato su questi 2 pin.

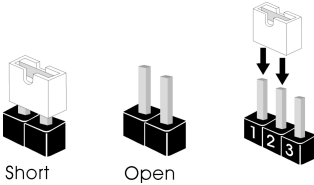

Jumper per azzerare la CMOS
(CLRCMOS1)
(vedere pag. 1, n. 3)



CLRCMOS1 consente di azzerare i dati presenti nella CMOS. Per azzerare e reimpostare i parametri del sistema alla configurazione predefinita, spegnere il computer e scollegare il cavo di alimentazione dalla rete. Dopo aver atteso 15 secondi, utilizzare un cappuccio del jumper per cortocircuitare il pin2 e il pin3 su CLRCMOS1 per 5 secondi. Tuttavia, non azzerare la CMOS subito dopo aver aggiornato il BIOS. Se è necessario azzerare la CMOS dopo l'aggiornamento del BIOS, è necessario riavviare prima il sistema e in seguito spegnerlo prima di eseguire l'operazione di azzeramento della CMOS. La password, la data, l'ora e il profilo predefinito dell'utente saranno azzerati solo se viene rimossa la batteria della CMOS.



Se si azzerare la CMOS, può essere rilevato il case aperto. Regolare l'opzione del BIOS "Azzerare stato" per azzerare il registro del precedente stato di intrusione nello chassis.

1.4 Header e connettori sulla scheda



Gli header e i connettori sulla scheda NON sono jumper. NON posizionare cappucci del jumper su questi header e connettori. Il posizionamento di cappucci del jumper su header e connettori provocherà danni permanenti alla scheda madre.

Header sul pannello del sistema
(PANEL1 a 9 pin)
(vedere pag. 1, n. 8)

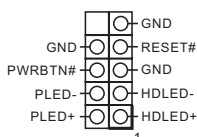

Collegare l'interruttore dell'alimentazione, l'interruttore di reset e l'indicatore dello stato del sistema sullo chassis su questo header secondo la seguente assegnazione dei pin. Annotare i pin positivi e negativi prima di collegare i cavi.



PWRBTN (interruttore di alimentazione):

collegare all'interruttore dell'alimentazione sul pannello anteriore dello chassis. È possibile configurare il modo in cui spegnere il sistema utilizzando l'interruttore dell'alimentazione.

RESET (interruttore di reset):

collegare all'interruttore di reset sul pannello anteriore dello chassis. Premere l'interruttore di reset per riavviare il computer se il computer si blocca e non riesce ad eseguire un normale riavvio.

PLED (LED alimentazione del sistema):

collegare all'indicatore di stato dell'alimentazione sul pannello anteriore dello chassis. Il LED è acceso quando il sistema è in funzione. Il LED continua a lampeggiare quando il sistema si trova nello stato di sospensione S1/S3. Il LED è spento quando il sistema si trova nello stato di sospensione S4 o quando è spento (S5).

HDLED (LED di attività disco rigido):

collegare al LED di attività disco rigido sul pannello anteriore dello chassis. Il LED è acceso quando il disco rigido sta leggendo o scrivendo dati.

Il design del pannello anteriore può cambiare a seconda dello chassis. Un modulo di pannello anteriore è composto principalmente da interruttore di alimentazione, interruttore di reset, LED di alimentazione, LED di attività disco rigido, altoparlante, ecc. Quando si collega il modulo del pannello anteriore dello chassis a questo header, accertarsi che le assegnazioni del filo e le assegnazioni dei pin corrispondano correttamente.

Connettori Serial ATA3

(SATA3_0:
vedere pag.1, n. 9)
(SATA3_1:
vedere pag.1, n. 10)



Questi due connettori SATA3 supportano cavi dati SATA per dispositivi di archiviazione interna, con una velocità di trasferimento dati fino a 6,0 Gb/s.

Header USB 2.0
(USB10_11 a 9 pin)
(vedere pag. 1, n. 8)

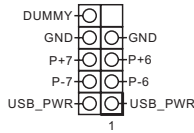

Oltre alle due porte USB 2.0 sul pannello I/O, su questa scheda madre vi è un header. Ciascun header USB 2.0 può supportare due porte.

Header audio pannello anteriore
(AUDIO1_HD a 9 pin)
(vedere pag. 1, n. 16)

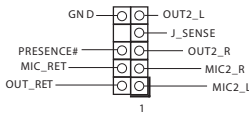

Questo header serve a collegare i dispositivi audio al pannello audio anteriore.



1. L'audio ad alta definizione supporta le funzioni Jack sensing, ma il filo del pannello sullo chassis deve supportare HDA per funzionare correttamente. Seguire le istruzioni presenti nel nostro manuale e nel manuale dello chassis per installare il sistema.
2. Se si utilizza un pannello audio AC'97, installarlo sull'header audio del pannello anteriore seguendo le fasi di seguito:
 - A. Collegare Mic_IN (MIC) a MIC2_L.
 - B. Collegare Audio_R (RIN) a OUT2_R e Audio_L (LIN) a OUT2_L.
 - C. Collegare Ground (GND) a Ground (GND).
 - D. MIC_RET e OUT_RET servono soltanto per il pannello audio HD. Non è necessario collegarli per il pannello audio AC'97.
 - E. Per attivare il microfono anteriore, andare alla scheda "MicAnt" nel pannello di controllo Realtek e regolare il "Volume di registrazione".

Connettore della ventola dello chassis (CHA_FAN1 a 4 pin) (vedere pag. 1, n. 11)

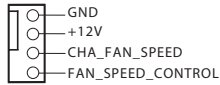

Collegare il cavo della ventola al connettore della ventola e far corrispondere il filo nero al pin di terra.

Connettori della ventola della CPU (CPU_FAN1 a 4 pin) (vedere pag. 1, n. 6)

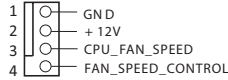

Questa scheda madre è dotata di un connettore per la ventola della CPU (Ventola silenziosa) a 4 pin. Se si decide di collegare una ventola della CPU a 3 pin, collegarla al pin 1-3.

Connettore di alimentazione ATX (ATXPWR1 a 24 pin) (vedere pag. 1, n. 5)

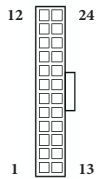

Questa scheda madre è dotata di un connettore di alimentazione ATX a 24 pin. Per utilizzare un'alimentazione ATX a 20 pin, collegarla lungo il pin1 e il pin 13.

Connettore di alimentazione ATX da 12 V (ATX12V1 a 8 pin) (vedere pag. 1, n. 1)

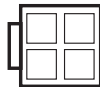

Questa scheda madre è dotata di un connettore di alimentazione ATX da 12 V a 8 pin. Per utilizzare un'alimentazione ATX a 4 pin, collegarla lungo il pin1 e il pin 5.

Header di intrusione nello chassis (CI1 a 2 pin) (vedere pag. 1, n. 4)



Questa scheda madre supporta la funzionalità di rilevamento CASE OPEN che rileva se il coperchio dello chassis è stato rimosso. Questa funzione richiede uno chassis con caratteristiche di rilevamento di intrusione nello chassis.

Header TPM
(TPMS1 a 17 pin)
(vedere pag. 1, n. 12)

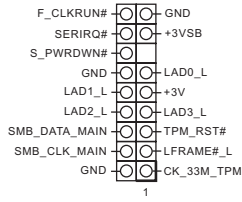

Questo connettore supporta il sistema Trusted Platform Module (TPM), che può archiviare in modo sicuro chiavi, certificati digitali, password e dati. Un sistema TPM permette anche di potenziare la sicurezza della rete, di proteggere identità digitali e di garantire l'integrità della piattaforma.

1 Introducción

Gracias por comprar la placa base ASRock H81M-ITX, una placa base fiable fabricada según el rigurosísimo control de calidad de ASRock. Ofrece un rendimiento excelente con un diseño resistente de acuerdo con el compromiso de calidad y resistencia de ASRock.



Ya que las especificaciones de la placa base y el software del BIOS podrán ser actualizados, el contenido que aparece en esta documentación estará sujeto a modificaciones sin previo aviso. Si esta documentación sufre alguna modificación, la versión actualizada estará disponible en el sitio web de ASRock sin previo aviso. Si necesita asistencia técnica relacionada con esta placa base, visite nuestro sitio web para obtener información específica sobre el modelo que esté utilizando. Podrá encontrar las últimas tarjetas VGA, así como la lista de compatibilidad de la CPU, en el sitio web de ASRock. Sitio web de ASRock <http://www.asrock.com>.

1.1 Contenido del paquete

- Placa base ASRock H81M-ITX (Factor de forma Mini-ITX)
- Guía de instalación rápida de ASRock H81M-ITX
- CD de soporte de ASRock H81M-ITX
- 2 cables de datos Serie ATA (SATA) (Opcional)
- 1 escudo panel I/O

1.2 Especificaciones

Plataforma

- Factor de forma Mini-ITX
- Diseño de los Condensadores: All Solid

CPU

- Compatible con 4.ª Generación de Intel® Core™ i7 / i5 / i3 / Xeon® / Pentium® / Celeron® en Paquete LGA1150
- Diseño de 4 fases de alimentación
- Compatible con la tecnología de Intel® Turbo Boost 2.0

Conjunto de chips

- Intel® H81

Memoria

- Tecnología de memoria de Doble Canal DDR3
- 2 ranuras DDR3 DIMM
- Compatible con memoria no-ECC, sin búfer DDR3 1600/1333/1066
- Capacidad máxima de la memoria del sistema: 16GB (consulte la ADVERTENCIA)
- Compatible con Extreme Memory Profile (XMP) 1.3/1.2 de Intel®

Ranura de expansión

- 1 ranura PCI Express 2.0 x16

Gráficos

- La Tecnología visual integrada de gráficos HD de Intel® y las salidas de VGA son compatibles únicamente con procesadores con GPU integrado.
- Compatible con la Tecnología visual integrada de gráficos HD de Intel®: Intel® Quick Sync Video con AVC, MVC (S3D) y MPEG-2 Full HW Encode1, Intel® InTru™ 3D, Intel® Clear Video HD Technology, Intel® Insider™, Intel® HD Graphics 4400/4600
- Pixel Shader 5.0, DirectX 11.1
- Memoria compartida máxima: 1792MB
- Tres opciones de salida VGA: D-Sub, DVI-D y HDMI
- Compatible con Tecnología HDMI con máxima resolución hasta 1920x1200 @ 60Hz
- Compatible con DVI-D con máxima resolución hasta 1920x1200 @ 60Hz

- Compatible con D-Sub con máxima resolución hasta 1920x1200 @ 60Hz
- Compatible con Auto Lip Sync, Deep Color (12bpc), xvYCC y HBR (audio de alta velocidad de bits) con HDMI (requiere un monitor compatible con HDMI)
- Compatible con función HDCP con puertos DVI-D y HDMI
- Compatible con reproducción Blu-ray (BD) Full HD de 1080p con puertos DVI-D y HDMI

Audio

- 7.1 Audio CH HD con Protección de contenido (Realtek ALC892 Audio Codec)
- Compatible con audio Blu-ray Premium

LAN

- 1 LAN Gigabit PCIE 10/100/1000 Mb/s
- Qualcomm® Atheros® AR8171
- Compatible con la Tecnología de seguridad en internet Wake On Qualcomm® Atheros®
- Compatible con Wake-On-LAN
- Compatible con Ethernet de consumo eficiente de energía 802.3az
- Compatible con PXE

Panel trasero I/O

- 1 puerto de ratón/teclado PS/2
- 1 puerto D-Sub
- 1 puerto DVI-D
- 1 puerto HDMI
- 1 puerto de salida SPDIF óptica
- 1 conector eSATA
- 4 puertos USB 2.0
- 2 puertos USB 3.0
- 1 puerto LAN RJ-45 con LED (ACT/LINK LED y SPEED LED)
- Conector de audio HD: Altavoz trasero / Central / Graves / Entrada de línea / Altavoz frontal / Micrófono

Almacenamiento

- Los 2 conectores SATA3 de 6,0 Gb/s, compatible con las funciones NCQ, AHCI y Hot Plug
- 1 conector eSATA, compatible con las funciones NCQ, AHCI y Hot Plug

Conectores

- 1 cabezal de intrusión de chasis
- 1 cabezal TPM
- 1 conector de ventilador de la CPU (de 4 pines)
- 1 conector de ventilador de chasis (de 4 pines)
- 1 conector de alimentación ATX de 24 pines
- 1 conector de alimentación de 12V de 4 pines
- 1 conector de audio del panel frontal
- 1 cabezal USB 2.0 (compatible con 2 puertos USB 2.0)

Características del BIOS

- BIOS legal UEFI AMI de 32Mb compatible con interfaz gráfica de usuario multilingüe
- Eventos de reactivación conformes con ACPI 1.1
- Compatible con SMBIOS 2.3.1
- Multiajuste de voltaje de CPU, DRAM, PCH 1,05V, PCH 1,5V

CD de soporte

- Controladores, Utilidades, Software AntiVirus (Versión de prueba), Versión de prueba de CyberLink MediaEspresso 6.5, Explorador y Barra de herramientas de Google Chrome, Start8 (Versión de prueba de 30 días)

Monitor del hardware

- Método de sensor de temperatura de la CPU/Chasis
- Tacómetro de la CPU/Chasis
- Ventilador silencioso de la CPU/Chasis (permite ajustar automáticamente la velocidad del ventilador del chasis mediante la temperatura de la CPU)
- Control multivelocidad del ventilador de la CPU/Chasis
- Detección de CUBIERTA ABIERTA
- Control del voltaje: +12V, +5V, +3,3V, CPU Vcore

SO

- Compatible con Microsoft® Windows® 8 / 8 de 64 bits / 7 / 7 de 64 bits

Certificaciones

- FCC, CE, WHQL
- Compatible con ErP/EuP (requiere toma de alimentación compatible con ErP/EuP)

* Para obtener más información acerca del producto, visite nuestro sitio web: <http://www.asrock.com>



Debido a las limitaciones, el tamaño real de la memoria podrá ser inferior a 4GB para reservar espacio para el uso del sistema en sistemas operativos Windows® de 32 bits. Los sistemas operativos Windows® de 64 bits no tienen estas limitaciones. Podrá utilizar XFast RAM de ASRock para usar la memoria que Windows® no puede utilizar.

1.3 Instalación de los puentes

La instalación muestra cómo deben instalarse los puentes. Cuando la tapa de puente se coloca en los pines, el puente queda “Corto”. Si no coloca la tapa de puente en los pines, el puente queda “Abierto”. La ilustración muestra un puente de 3 pines cuyo pin 1 y pin 2 son “Cortos” cuando se coloca una tapa de puente en estos 2 pines.

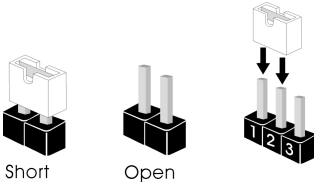

Puente de borrado de
CMOS
(CLRCMOS1)
(consulte la pág.1, N.º 3)

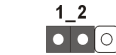

Predeterminado



Borrado de CMOS

CLRCMOS1 le permite borrar los datos del CMOS. Para borrar y restablecer los parámetros del sistema a los valores predeterminados de instalación, apague el ordenador y desenchufe el cable de alimentación de la toma de alimentación. Después de esperar 15 segundos, utilice un tapa de puente para acortar el pin2 y el pin3 en el CLRCMOS1 durante 5 segundos. Sin embargo, no borre el CMOS justo después de que haya actualizado el BIOS. Si necesita borrar el CMOS cuando acabe de actualizar el BIOS, deberá arrancar el sistema primero y, a continuación, deberá apagarlo antes de que realice el borrado del CMOS. Tenga en cuenta que la contraseña, la fecha, la hora y el perfil de usuario predeterminado serán eliminados únicamente si se retira la pila del CMOS.



Si borra el CMOS, podrá detectarse la cubierta abierta. Ajuste la opción del BIOS “Clear Status” (Borrar estado) para borrar el registro del estado de intrusión anterior del chasis.

1.4 Conectores y cabezales incorporados



Los cabezales y conectores incorporados NO son puentes. NO coloque tapas de puente sobre estos cabezales y conectores. Si coloca tapas de puente sobre los cabezales y conectores dañará de forma permanente la placa base.

Cabezal del panel del sistema
(PANEL1 de 9 pines)
(consulte la pág.1, N.º 8)

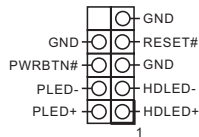

Conecte el interruptor de alimentación, restablezca el interruptor y el indicador del estado del sistema del chasis a los valores de este cabezal, según los valores asignados a los pines como se indica a continuación. Cerciórese de cuáles son los pines positivos y los negativos antes de conectar los cables.



PWRBTN (Interruptor de alimentación):

Conéctelo al interruptor de alimentación del panel frontal del chasis. Deberá configurar la forma en la que su sistema se apagará mediante el interruptor de alimentación.

RESET (Interruptor de reseteo):

Conéctelo al interruptor de reseteo del panel frontal del chasis. Pulse el interruptor de reseteo para resetear el ordenador si éste está bloqueado y no se puede reiniciar de forma normal.

PLED (Indicador LED de la alimentación del sistema):

Conéctelo al indicador de estado de la alimentación del panel frontal del chasis. El indicador LED permanece encendido cuando el sistema está funcionando. El indicador LED parpadea cuando el sistema se encuentra en estado de suspensión S1/S3. El indicador LED se apaga cuando el sistema se encuentra en estado de suspensión S4 o está apagado (S5).

HDLED (Indicador LED de actividad en el disco duro):

Conéctelo al indicador LED de actividad en el disco duro del panel frontal del chasis. El indicador LED permanece encendido cuando el disco duro está leyendo o escribiendo datos.

El diseño del panel frontal puede ser diferente dependiendo del chasis. Un módulo de panel frontal consta principalmente de: interruptor de alimentación, interruptor de reseteo, indicador LED de alimentación, indicador LED de actividad en el disco duro, altavoz, etc. Cuando conecte su módulo del panel frontal del chasis a este cabezal, asegúrese de que las asignaciones de los cables y los pines coinciden correctamente.

Conectores Serie ATA3

(SATA3_0:

consulte la pág.1, N.º 9)

(SATA3_1:

consulte la pág.1, N.º 10)



Estos dos conectores

SATA3 son compatibles

con cables de datos SATA

para dispositivos de

almacenamiento interno

con una velocidad de

transferencia de datos de

hasta 6,0 Gb/s.

Cabezales USB 2.0

(USB10_11 de 9 pines)

(consulte la pág.1, N.º 8)

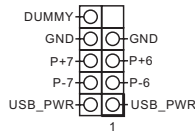

Además de dos puertos

USB 2.0 en el panel I/O,

esta placa base contiene un

cabezal. Cada cabezal USB

2.0 admite dos puertos.

Cabezal de audio del panel

frontal

(HD_AUDIO1 de 9 pines)

(consulte la pág.1, N.º 16)

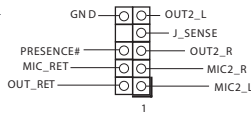

Este cabezal se utiliza para

conectar dispositivos de

audio al panel de audio

frontal.



1. El Audio de Alta Definición (HDA, en inglés) es compatible con el método de sensor de conectores, sin embargo, el cable del panel del chasis deberá ser compatible con HDA para que pueda funcionar correctamente. Siga las instrucciones que se indican en nuestro manual y en el manual del chasis para instalar su sistema.
2. Si utiliza un panel de audio AC'97, colóquelo en el cabezal de audio del panel frontal siguiendo los pasos que se describen a continuación:
 - A. Conecte Mic_IN (MIC) a MIC2_L.
 - B. Conecte Audio_R (RIN) a OUT2_R y Audio_L (LIN) a OUT2_L.
 - C. Conecte Ground (Conexión a tierra) (GND) a Ground (GND).
 - D. MIC_RET y OUT_RET se utilizan únicamente con el panel de audio HD. No es necesario que los conecte en el panel de audio AC'97.
 - E. Para activar el micrófono frontal, vaya a la ficha "micrófono frontal" (FrontMic) en el panel de control de Realtek y ajuste el "Volumen de grabación" (Recording Volume).

Conector del ventilador
del chasis
(CHA_FAN1 de 4 pines)
(consulte la pág.1, N.º 14)

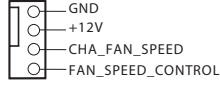

Conecte el cable del ventilador al conector del ventilador y haga coincidir el cable negro con el pin de conexión a tierra.

Conectores del ventilador
de la CPU
(CPU_FAN1 de 4 pines)
(consulte la pág.1, N.º 6)

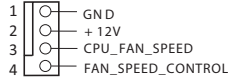

Esta placa base contiene un conector de ventilador (ventilador silencioso) de CPU de 4 pines. Si tiene pensando conectar un ventilador de CPU de 3 pines, conéctelo al Pin 1-3.

Conector de alimentación
ATX
(ATXPWR1 de 24 pines)
(consulte la pág.1, N.º 5)

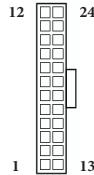

Esta placa base contiene un conector de alimentación ATX de 24 pines. Para utilizar una toma de alimentación ATX de 20 pines, conéctela en los Pines del 1 al 13.

Conector de alimentación
ATX de 12V
(ATX12V1 de 8 pines)
(consulte la pág.1, N.º 1)



Esta placa base contiene un conector de alimentación ATX de 12V y 8 pines. Para utilizar una toma de alimentación ATX de 4 pines, conéctela en los Pines del 1 al 5.

Cabezal de intrusión de
chasis
(CI1 de 2 pines)
(consulte la pág.1, N.º 4)



Esta placa base es compatible con la función de detección de CUBIERTA ABIERTA que detecta si se ha retirado la cubierta del chasis. Esta función requiere un chasis diseñado para la detección de intrusión del chasis.

Cabezal TPM

(TPMS1 de 17 pines)

(consulte la pág.1, N.º 15)

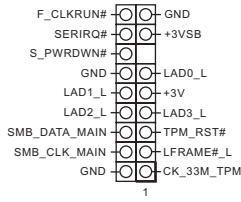

Este conector es compatible con el sistema Módulo de Plataforma Segura (TPM, en inglés), que puede almacenar de forma segura claves, certificados digitales, contraseñas y datos. Un sistema TPM también ayuda a aumentar la seguridad en la red, protege las identidades digitales y garantiza la integridad de la plataforma.

1 Введение

Благодарим вас за приобретение надежной материнской платы ASRock H81M-ITX, выпускаемой под постоянным строгим контролем компании ASRock. Эта материнская плата обеспечивает великолепную производительность и характеризуется прочной конструкцией в соответствии с требованиями компании ASRock в отношении качества и долговечности.



По причине обновления спецификации на материнскую платформу и программного обеспечения BIOS содержимое настоящей документации может быть изменено без предварительного уведомления. При изменении содержимого настоящего документа его обновленная версия будет доступна на веб-сайте ASRock без предварительного уведомления. При необходимости технической поддержки, связанной с материнской платой, посетите веб-сайт и найдите на нем информацию о модели используемой вами материнской платы. На веб-сайте ASRock также можно найти самый последний перечень поддерживаемых VGA-карт и ЦП. Веб-сайт ASRock <http://www.asrock.com>.

1.1 Комплект поставки

- Материнская плата ASRock H81M-ITX (форм-фактор Mini-ITX)
- Краткое руководство по установке ASRock H81M-ITX
- Диск с ПО для ASRock H81M-ITX
- 2 x кабеля передачи данных Serial ATA (SATA) (приобретаются отдельно)
- 1 x экран панели с портами ввода-вывода

1.2 Спецификация

Платформа	<ul style="list-style-type: none"> • Форм-фактор Mini-ITX • Использование только твердотельных конденсаторов
ЦП	<ul style="list-style-type: none"> • Поддержка процессоров 4-го поколения Intel® Core™ i7 / i5 / i3 / Xeon® / Pentium® / Celeron® в исполнении LGA1150 • Система питания 4 • Поддержка технологии Intel® Turbo Boost 2.0
Чипсет	<ul style="list-style-type: none"> • Intel® H81
Память	<ul style="list-style-type: none"> • Двухканальная память DDR3 • 2 x гнездо DDR3 DIMM • Поддержка модулей памяти DDR3 1600/1333/1066 Non-ECC Unbuffered • Максимальный объем системной памяти: 16 Гб (см. «ПРЕДОСТЕРЕЖЕНИЕ») • Поддержка Intel® Extreme Memory Profile (XMP)1.3/1.2
Гнезда расширения	<ul style="list-style-type: none"> • 1 x PCI Express 2.0 x16
Графическая система	<ul style="list-style-type: none"> • Поддержка выходных сигналов Intel® HD Graphics Built-in Visuals и VGA возможна только при использовании процессоров со встроенными графическими процессорами. • Поддержка встроенных технологий визуализации Intel® HD Graphics: Intel® Quick Sync Video с AVC, MVC (S3D) и MPEG-2 Full HW Encode1, Intel® InTru™ 3D, Intel® Clear Video HD Technology, Intel® Insider™, Intel® HD Graphics 4400/4600 • Pixel Shader 5.0, DirectX 11.1 • Максимальный объем совместно используемой памяти: 1792 Мб • Три выхода VGA: D-Sub, DVI-D и HDMI • Поддержка технологии HDMI с максимальным разрешением до 1920x1200 при 60 Гц • Поддержка DVI-D с максимальным разрешением до 1920x1200 при 60 Гц

- Поддержка D-Sub с максимальным разрешением до 1920x1200 при 60 Гц
- Поддержка Auto Lip Sync, Deep Color (12bpc), xvYCC и HBR (High Bit Rate Audio) по HDMI (необходим HDMI-совместимый монитор)
- Поддержка функции HDCP через порты DVI-I и HDMI
- Поддержка воспроизведения Full HD 1080p Blu-ray (BD) через порты DVI-D и HDMI

Аудио

- 7.1-канальный звук высокой четкости HD Audio с защитой данных (аудиокодек Realtek ALC892)
- Поддержка Premium Blu-ray Audio

ЛВС

- PCIE x1 Gigabit LAN 10/100/1000 Мб/с
- Qualcomm® Atheros® AR8171
- Поддержка технологии Qualcomm® Atheros® Security Wake On Internet Technology
- Поддержка Wake-On-LAN
- Поддержка Energy Efficient Ethernet 802,3az
- Поддержка PXE

Порты ввода-вывода на задней панели

- 1 х порт мыши/клавиатуры PS/2
- 1 х D-Sub
- 1 х DVI-D
- 1 х HDMI
- 1 х оптический выходной SPDIF
- 1 х eSATA
- 4 х USB 2.0
- 2 х USB 3.0
- 1 х RJ-45 для ЛВС с СИД (СИД ACT/LINK и МИД SPEED)
- Разъемы HD Audio: задние динамики / центральный динамик / сабвуфер / линейный вход / передние динамики / микрофон

Запоминающие устройства

- 2 х разъем SATA3 6,0 Гб/с, поддержка функций NCQ, AHCI и горячей замены
- 1 х разъем eSATA, поддержка функций NCQ, AHCI и горячей замены

Разъемы

- 1 х колодка для датчика вскрытия корпуса
- 1 х колодка TPM
- 1 х разъем для вентилятора ЦП (4-контактный)
- 1 х разъем для вентилятора корпуса (4-контактный)
- 1 х разъем питания ATX (24-контактный)
- 1 х 4-контактный разъем питания 12 В
- 1 х аудиоразъем на передней панели
- 1 х колодка USB 2.0 (поддержка 2 портов USB 2.0)

Особенности BIOS

- 32 Мб AMI UEFI Legal BIOS с поддержкой многоязычного ГИП
- Совместимость с управлением энергопотреблением по ACPI 1.1
- Поддержка SMBIOS 2.3.1
- Регулировка напряжений ЦП, DRAM, PCN 1,05 В, PCN 1,5 В

Диск с ПО

- Драйвера, утилиты, антивирусное ПО (демоверсия), CyberLink MediaEspresso 6.5 (демоверсия), браузер и панель инструментов Google Chrome, Start8 (демоверсия на 30 дней)

Контроль оборудования

- Датчик температуры ЦП/корпуса
- Тахометр вентиляторов ЦП/корпуса
- Малощумящий вентилятор ЦП/корпуса (с автоматической регулировкой оборотов по температуре ЦП)
- Управление оборотами вентилятора ЦП/корпуса
- Технология определения вскрытия корпуса
- Контроль напряжения: +12 В, +5 В, +3,3 В, ЦП Vcore

ОС

- Microsoft® Windows® 8 / 8 64-разрядная / 7 / 7 64-разрядная

Сертификация

- FCC, CE, WHQL
- Совместимость с ErP/EuP (необходим блок питания, соответствующий стандарту ErP/EuP)

* Для получения дополнительной информации об изделии посетите наш веб-сайт:
<http://www.asrock.com>



В связи с ограничением при работе под 32-разрядной ОС Windows® фактический объем памяти может быть меньше 4 Гбайт. Для 64-разрядных ОС Windows® таких ограничений нет. Для использования той памяти, которую ОС Windows® не может использовать, используйте ASRock XFast RAM.

1.3 Установка перемычек

Установка перемычек показана на рисунке. При установке колпачковой перемычки на контакты перемычка «замкнута». Если колпачковая перемычка на контакты не установлена, перемычка «разомкнута». На рисунке показана 3-контактная перемычка с замкнутыми контактами 1 и 2 при установке на них колпачковой перемычки.

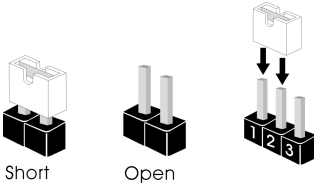

Перемычка сброса
настроек CMOS
(CLRCMOS1)
(См. стр. 1, № 3)



CLRCMOS1 используется для удаления данных CMOS. Чтобы сбросить и обнулить параметры системы на настройки по умолчанию, выключите компьютер и извлеките кабель питания от источника питания. Подождите 15 секунд и перемычкой замкните контакты 2 и 3 на CLRCMOS1 на 15 секунд. Не сбрасывайте настройки CMOS сразу после обновления BIOS. При необходимости сбросить настройки CMOS сразу после обновления BIOS сначала перезагрузите систему, а затем выключите компьютер перед сбросом настроек CMOS. Учтите, что пароль, дата, время и профиль пользователя по умолчанию сбрасываются только в том случае, если извлечь батарею CMOS.



Сброс настроек CMOS может привести к определению вскрытия корпуса. Чтобы обнулить запись предыдущего определения вскрытия корпуса, используйте параметр Clear Status (Обнулить состояние) BIOS.

1.4 Колодки и разъемы, расположенные на материнской плате



Расположенные на материнской плате колодки и разъемы перемычками НЕ являются. НЕ устанавливайте на эти колодки и разъемы колпачковые перемычки. Установка колпачковых перемычек на эти колодки и разъемы может вызвать неустранимое повреждение материнской платы.

Колодка системной панели
(9-контактная, PANEL1)
(См. стр. 1, № 8)

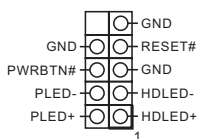

Подключите расположенные на корпусе выключатель питания, кнопку перезагрузки и индикатор состояния системы к этой колодке в соответствии с распределением контактов, приведенным ниже. Перед подключением кабелей определите положительный и отрицательный контакты.



PWRBTN (кнопка питания):

Подключение кнопки питания, расположенной на передней панели корпуса. Можно настроить порядок выключения системы с использованием кнопки питания.

RESET (кнопка перезагрузки):

Подключение кнопки перезагрузки системы, расположенной на передней панели корпуса. Нажмите кнопку перезагрузки, чтобы перезапустить компьютер, если он завис и нормальный запуск невозможен.

PLED (светодиодный индикатор питания системы):

Подключение индикатора состояния, расположенного на передней панели корпуса. Светодиодный индикатор горит, когда система работает. Когда система находится в режиме ожидания S1/S3, светодиод мигает. Когда система находится в режиме ожидания S4 или выключена (S5), светодиод не горит.

HDLED (светодиодный индикатор работы жесткого диска):

Подключение светодиодного индикатора работы жесткого диска, расположенного на передней панели. Светодиодный индикатор горит, когда жесткий диск выполняет считывание или запись данных.

Передняя панель может быть разной на разных корпусах. В основном передняя панель включает в себя кнопку питания, кнопку перезагрузки, светодиодный индикатор питания, светодиодный индикатор работы жесткого диска, динамик и т. д. При подключении передней панели к этой колодке правильно подключайте провода к контактам.

Разъемы Serial ATA3

(SATA3_0:

см. стр.1, № 9)

(SATA3_1:

см. стр.1, № 10)



Эти два разъема SATA3

предназначены для

подключения кабелей

SATA внутренних

запоминающих

устройств для передачи

данных со скоростью до

6,0 Гб/с.

Колодки USB 2.0.

(9-контактная,

USB10_11)

(См. стр. 1, № 8)

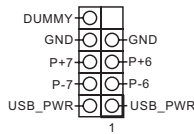

Кроме двух портов USB

2.0 на панели ввода-

вывода на материнской

плате также есть

одна колодка. Каждая

колодка USB 2.0 может

поддерживать два порта.

Аудиоколодка передней панели

(9-контактная, HD_ AUDIO1)

(См. стр. 1, № 16)

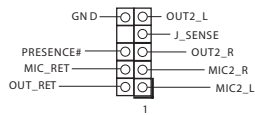

Эта колодка

предназначена

для подключения

аудиоустройств к

передней аудиопанели.



1. Аудиосистема высокого разрешения поддерживает функцию распознавания разъема, но для ее правильной работы необходимо, чтобы провод панели корпуса поддерживал передачу сигналов HDA. Инструкции по установке системы см. в этом руководстве и руководстве на корпус.
2. При использовании аудиопанели AC'97 подключите ее к аудиоколодке передней панели, как указано далее:
 - A. Подключите Mic_IN (MIC) к MIC2_L.
 - B. Подключите Audio_R (RIN) к OUT2_R, Audio_L (LIN) к OUT2_L.
 - C. Подключите провод заземления (GND) к контакту заземления (GND).
 - D. Контакты MIC_RET и OUT_RET используются только для аудиопанели высокого разрешения. При использовании аудиопанели AC'97 их подключать не нужно.
 - E. Чтобы активировать передний микрофон, перейдите на вкладку FrontMic панели управления Realtek и отрегулируйте параметр Recording Volume (Громкость записи).

Разъем вентилятора корпуса
(4-контактный,
CHA_FAN1)
(См. стр. 1, № 14)

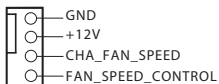

Предназначен для подключения кабеля разъема вентилятора и подключения черного провода к заземлению.

Разъемы вентиляторов ЦП
(4-контактный,
CPU_FAN1)
(См. стр. 1, № 6)

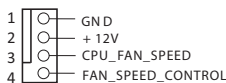

Эта материнская плата снабжена 4-контактным разъемом для малошумящего вентилятора ЦП. Если вы собираетесь подключить 3-контактный вентилятор охлаждения процессора, подключайте его к контактам 1-3.

Разъем питания ATX
(24-контактный,
ATXPWR1)
(См. стр. 1, № 5)

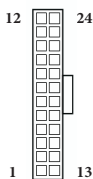

Эта материнская плата снабжена 24-контактным разъемом питания ATX. Чтобы использовать 20-контактный разъем питания ATX, подключите его вдоль контакта 1 и контакта 13.

Разъем питания ATX 12 В
(8-контактный,
ATX12V1)
(См. стр. 1, № 1)



Эта материнская плата снабжена 8-контактным разъемом питания ATX 12 В. Чтобы использовать 4-контактный разъем питания ATX, подключите его вдоль контакта 1 и контакта 5.

Колодка для датчика
вскрытия корпуса
(2-контактная, С11)
(См. стр. 1, № 4)

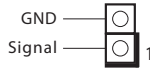

Эта материнская плата поддерживает технологию определения вскрытия корпуса по снятию верхней части корпуса. Для этой технологии необходим корпус с функцией определения вскрытия.

Колодка TPM
(17-контактная, TPMS1)
(См. стр. 1, № 15)

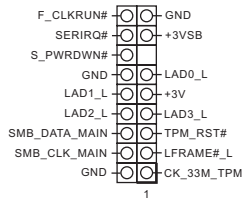

Этот разъем обеспечивает поддержку системы Trusted Platform Module (TPM), которая способна обеспечить надежное хранение ключей, цифровых сертификатов, паролей и данных. Система TPM также повышает уровень сетевой безопасности, защищает цифровые идентификаторы и обеспечивает целостность платформы.

1 Introdução

Obrigado por ter comprado a placa principal ASRock H81M-ITX, uma placa principal fiável produzida sob os rigorosos critérios de controlo de qualidade da ASRock. Esta placa principal oferece um excelente desempenho com um design robusto em conformidade com o compromisso da ASRock em fabricar produtos de qualidade e resistentes.



Dado que as especificações da placa principal e o software do BIOS poderão ser actualizados, o conteúdo desta documentação estará sujeito a alterações sem aviso prévio. Caso ocorram modificações a esta documentação, a versão actualizada estará disponível no Web site da ASRock sem aviso prévio. Se necessitar de assistência técnica relacionada com esta placa principal, visite o nosso Web site para obter informações específicas acerca do modelo que está a utilizar. Também poderá encontrar a lista de placas VGA e CPU mais recentes suportadas no Web site da ASRock. Web site da ASRock <http://www.asrock.com>.

1.1 Conteúdo da embalagem

- Placa principal ASRock H81M-ITX (Formato Mini-ITX)
- Guia de instalação rápida da placa ASRock H81M-ITX
- CD de suporte ASRock H81M-ITX
- 2 x Cabos de dados Serial ATA (SATA) (Opcional)
- 1 x Painel de E/S

1.2 Especificações

- Plataforma**
- Formato Mini-ITX
 - Design de condensador sólido

- CPU**
- Suporta processadores Intel® Core™ i7 / i5 / i3 / Xeon® / Pentium® / Celeron® de 4ª geração em socket LGA1150
 - Design com 4 fases de alimentação
 - Suporta a tecnologia Intel® Turbo Boost 2.0

- Chipset**
- Intel® H81

- Memória**
- Tecnologia de memória DDR3 de dois canais
 - 2 x ranhuras DIMM DDR3
 - Suporta memória DDR3 1600/1333/1066, não ECC, sem memória intermédia
 - Capacidade máxima da memória do sistema: 16GB (consultar AVISO)
 - Suporta Extreme Memory Profile (XMP) 1.3/1.2 da Intel®

- Ranhuras de Expansão**
- 1 x ranhura PCI Express 2.0 x16

- Gráficos**
- Os gráficos incorporados Intel® HD e as saídas VGA apenas podem ser suportados com processadores com GPU integrada.
 - Suporta gráficos incorporados Intel® HD: Intel® Quick Sync Video com AVC, MVC (S3D) e MPEG-2 Full HW Encode1, Intel® InTru™ 3D, Tecnologia Intel® Clear Video HD, Intel® Insider™, Intel® HD Graphics 4400/4600
 - Pixel Shader 5.0, DirectX 11.1
 - Memória partilhada máxima de 1792MB
 - Três opções de saída VGA: D-Sub, DVI-D e HDMI
 - Suporta tecnologia HDMI com resolução máxima de até 1920x1200 @ 60Hz
 - Suporta DVI-D com resolução máxima de até 1920x1200 @ 60Hz

- Suporta D-Sub com resolução máxima de até 1920x1200 @ 60Hz
- Suporta Auto sincronização labial, Deep Color (12bpc), xvYCC e HBR (High Bit Rate Audio) com HDMI (É necessário um monitor compatível com HDMI)
- Suporta a função HDCP com portas DVI-D e HDMI
- Suporta reprodução Blu-ray (BD) Full HD a 1080p com portas DVI-D e HDMI

Áudio

- Áudio HD de 7.1 canais com protecção de conteúdo (Codec de áudio Realtek ALC892)
- Suporte áudio Blu-ray superior

LAN

- LAN Gigabit 10/100/1000 Mb/s PCIE x1
- Qualcomm® Atheros® AR8171
- Suporta a tecnologia Qualcomm® Atheros® Security Wake On Internet
- Suporta Wake-On-LAN
- Suporta IEEE 802.3az
- Suporta PXE

E/S do painel traseiro

- 1 x porta para mouse/teclado PS/2
- 1 x Porta D-Sub
- 1 x Porta DVI-D
- 1 x porta HDMI
- 1 x Porta de saída SPDIF óptica
- 1 x Conector eSATA
- 4 x portas USB 2.0
- 2 x portas USB 3.0
- 1 x Porta LAN RJ-45 com LED (LED ACT/LIGAÇÃO e LED DE VELOCIDADE)
- Ficha de áudio HD: Altifalante traseiro / Central / Graves / Entrada de linha / Altifalante frontal / Microfone

Armazenamento

- 2 x conectores SATA3 a 6,0 Gb/s, com suporte para as funções NCQ, AHCI e Hot Plug
- 1 x conector eSATA, com suporte para as funções NCQ, AHCI e Hot Plug

Conector

- 1 x Terminal de intrusão no chassis
- 1 x Terminal TPM
- 1 x Conector da ventoinha da CPU (4 pinos)
- 1 x Conector da ventoinha do chassis (4 pinos)
- 1 x conector de alimentação de 24 pinos ATX
- 1 x conector de alimentação de 12V de 4 pinos
- 1 x conector de áudio do painel frontal
- 1 x terminal USB 2.0 (suporte para 2 portas USB 2.0)

Funcionalidades da BIOS

- BIOS UEFI oficial da AMI com 32Mb com suporte de interface multilíngue
- Eventos de reactivação compatíveis com ACPI 1.1
- Suporta SMBIOS 2.3.1
- Multi-ajuste de tensão de CPU, DRAM, PCH 1,05V, PCH 1,5V

CD de suporte

- Controladores, Utilitários, Software antivírus (versão de avaliação), CyberLink MediaEspresso 6.5 - Versão de avaliação, Navegador e Barra de Ferramentas Google Chrome, Start8 (30 dias de avaliação)

Monitor de hardware

- Sensor de temperatura de CPU/Chassis
- Taquímetro de CPU/Chassis
- Ventoinha de CPU/Chassis silenciosa (Permite o ajuste automático da velocidade da ventoinha do chassis através da temperatura da CPU)
- Controlo de velocidade da ventoinha de CPU/Chassis
- Detecção de ABERTURA da CAIXA
- Monitorização da tensão: +12V, +5V, +3,3V, CPU Vcore

Sistema Operativo

- Compatível com Microsoft® Windows® 8 / 8 64-bits / 7 / 7 64-bits

Certificações

- FCC, CE, WHQL
- Preparada para ErP/EuP (é necessária uma fonte de alimentação preparada para ErP/EuP)

* Para obter informações detalhadas acerca do produto, visite o nosso Web site: <http://www.asrock.com>



Devido às limitações, o tamanho real da memória de 4GB reservada para utilização em sistemas operativos Windows® 32-bits poderá ser inferior. Os sistemas operativos Windows® 64-bits não possuem essas limitações. Pode utilizar o ASRock XFast RAM para dar uso à memória que o Windows® não utiliza.

1.3 Configuração dos jumpers

A imagem abaixo ilustra como os jumpers são configurados. Quando a tampa do jumper é colocada nos pinos, o jumper é "Curto". Se não for colocada uma tampa de jumper nos pinos, o jumper é "Aberto". A imagem ilustra um jumper de 3 pinos cujos pino1 e pino2 estão "Curtos" quando a tampa do jumper é colocada nestes 2 pinos.

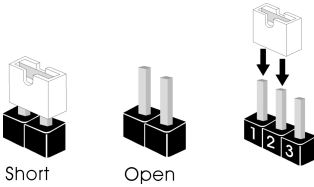

Jumper para limpar o
CMOS
(CLRCMOS1)
(consultar p.1, N.º 3)



CLRCMOS1 permite-lhe limpar os dados no CMOS. Para limpar e repor os parâmetros do sistema para os valores predefinidos, encerre o computador e desligue a ficha da tomada. Depois de aguardar 15 segundos, utilize uma tampa de jumper para ligar o pino2 e o pino3 no CLRCMOS1 durante 5 segundos. No entanto, não limpe o CMOS logo após ter efectuado a actualização da BIOS. Se precisar de limpar o CMOS logo após ter terminado uma actualização da BIOS, deverá primeiro iniciar o sistema e voltar a encerrá-lo antes de efectuar a acção de limpeza do CMOS. Tenha em atenção que a palavra-passe, data, hora e perfil predefinido de utilizador apenas serão limpos se a pilha do CMOS for retirada.



Se limpar o CMOS, poderá ser detectada a abertura da caixa. Ajuste a opção do BIOS "Limpar estado" para limpar o registo anterior de estado de intrusão no chassis.

1.4 Terminais e conectores integrados



Os terminais e conectores integrados **NÃO** são jumpers. **NÃO** coloque tampas de jumpers sobre estes terminais e conectores. Colocar tampas de jumpers sobre os terminais e conectores irá causar danos permanentes à placa principal.

Terminal do painel de sistema
(PAINEL1 de 9 pinos)
(consultar p.1, N.º 8)

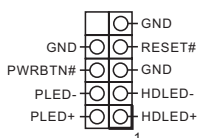

Ligue o botão de alimentação, o botão de reposição e o indicador do estado do sistema no chassis a este terminal de acordo com a descrição abaixo. Tenha em atenção os pinos positivos e negativos antes de ligar os cabos.



PWRBTN (Botão de alimentação):

Ligue ao botão de alimentação no painel frontal do chassis. Pode configurar a forma para desligar o seu sistema através do botão de alimentação.

RESET (Botão de reposição):

Ligue ao botão de reposição no painel frontal do chassis. Prima o botão de reposição para reiniciar o computador caso este bloqueie e não seja possível reiniciar normalmente.

PLED (LED de alimentação do sistema):

Ligue ao indicador do estado da alimentação no painel frontal do chassis. O LED ficará aceso quando o sistema estiver em funcionamento. O LED ficará intermitente quando o sistema estiver nos estados de suspensão S1/S3. O LED ficará desligado quando o sistema estiver no estado de suspensão S4 ou desligado (S5).

HDLED (LED de actividade do disco rígido):

Ligue ao LED de actividade do disco rígido no painel frontal do chassis. O LED ficará aceso quando o disco rígido estiver a ler ou a escrever dados.

O design do painel frontal poderá variar dependendo do chassis. Um módulo de painel frontal consiste principalmente em um botão de alimentação, um botão de reposição, um LED de alimentação, um LED de actividade do disco rígido, um altifalante, etc. Ao ligar o seu módulo de painel frontal do chassis a este conector, certifique-se de que os fios e os pinos têm uma correspondência exacta.

Conectores ATA3 de série
(SATA3_0:
consultar p.1, N.º 9)
(SATA3_1:
consultar p.1, N.º 10)



Estes dois conectores SATA3 suportam cabos de dados SATA para dispositivos de armazenamento interno com uma velocidade de transferência de dados de até 6,0 Gb/s.

Terminais USB 2.0
(USB10_11 de 9 pinos)
(consultar p.1, N.º 8)

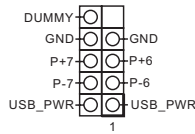

Para além das duas portas USB 2.0 no painel de E/S, existe um terminal nesta placa principal. Cada terminal USB 2.0 é capaz de suportar duas portas.

Terminal de áudio do
painel frontal
(HD_AUDIO1 de 9 pinos)
(consultar p.1, N.º 16)

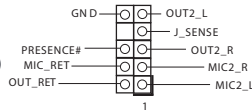

Este terminal destina-se à ligação de dispositivos áudio ao painel de áudio frontal.



1. O Áudio de alta definição suporta Detecção de ficha, mas o cabo de painel no chassis deverá suportar HDA para funcionar correctamente. Siga as instruções no nosso manual e no manual do chassis para instalar o seu sistema.
2. Se utilizar um painel de áudio AC'97, instale-o no terminal de áudio do painel frontal de acordo com os passos abaixo:
 - A. Ligue Mic_IN (MIC) a MIC2_L.
 - B. Ligue Audio_R (RIN) a OUT2_R e Audio_L (LIN) a OUT2_L.
 - C. Ligue Terra (GND) a Terra (GND).
 - D. MIC_RET e OUT_RET destinam-se apenas ao painel de áudio HD. Não precisa de os ligar para o painel de áudio AC'97.
 - E. Para activar o microfone frontal, aceda ao separador "Microfone Frontal" no painel de controlo Realtek e ajuste o "Volume de gravação".

Conector da ventoinha do chassis
(CHA_FAN1 de 4 pinos)
(consultar p.1, N.º 11)

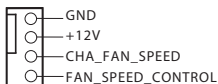

Ligue o cabos da ventoinha aos conectores da ventoinha colocando o cabo preto no pino de ligação à terra.

Conectores da ventoinha da CPU
(CPU_FAN1 de 4 pinos)
(consultar p.1, N.º 6)

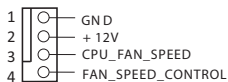

Esta placa principal inclui um conector de ventoinha de CPU (Ventoinha silenciosa) de 4 pinos. Se pretender ligar uma ventoinha de CPU de 3 pinos, ligue-a ao Pino 1-3.

Conector de alimentação ATX
(ATXPWR1 de 24 pinos)
(consultar p.1, N.º 5)

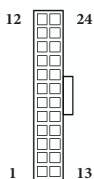

Esta placa principal inclui um conector de alimentação de ATX de 24 pinos. Para utilizar uma fonte de alimentação ATX de 20 pinos, introduza-a no Pino 1 e Pino 13.

Conector de alimentação de 12V ATX
(ATX12V1 de 8 pinos)
(consultar p.1, N.º 1)



Esta placa principal inclui um conector de alimentação de 12V ATX de 8 pinos. Para utilizar uma fonte de alimentação ATX de 4 pinos, introduza-a no Pino 1 e Pino 5.

Terminal de intrusão do chassis(CI1 de 2 pinos)
(consultar p.1, N.º 4)

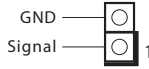

Esta placa principal suporta a função de detecção de ABERTURA da CAIXA que detecta se a tampa do chassis foi removida. Esta função requer um chassis com design de detecção de intrusão.

Terminal TPM
(TPMS1 de 17 pinos)
(consultar p.1, N.º 12)

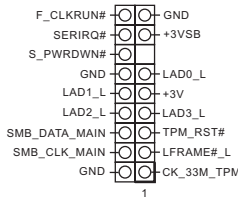

Este conector suporta um sistema com Módulo de Plataforma Confiável (TPM), que pode armazenar com segurança chaves, certificados digitais, palavras-passe e dados. Um sistema TPM também ajuda a melhorar a segurança de rede, a proteger identidades digitais e a garantir a integridade da plataforma.

1 Giriş

ASRock'ın zorlu kalite kontrol süreçlerinden geçmiş olan ASRock H81M-ITX anakartını satın aldığınız için teşekkür ederiz. Sağlam tasarımı ile ASRock'ın kalite ve dayanıklılık taahhüdüne uygun şekilde mükemmel performans sağlar.



Anakart özellikleri ve BIOS yazılımı güncellenebileceğinden, bu dokümantasyonun içeriği herhangi bir bildirimde bulunulmaksızın değiştirilebilir. Bu dokümantasyon üzerinde herhangi bir değişiklik yapılması halinde, güncellenmiş sürüm, herhangi bir bildirim yapılmaksızın ASRock'ın web sitesinde yer alacaktır. Bu anakart ile ilgili olarak teknik destek almak istiyorsanız, lütfen kullandığımız model hakkında özel bilgiler için web sitemizi ziyaret edin. En güncel VGA kartları ve CPU destek listelerini de ASRock'ın web sitesinden bulabilirsiniz. ASRock web sitesi <http://www.asrock.com>.

1.1 Ambalaj İçeriği

- ASRock H81M-ITX Anakartı (Mini-ITX Form Faktörü)
- ASRock H81M-ITX Hızlı Kurulum Kılavuzu
- ASRock H81M-ITX Destek CD'si
- 2 x Seri ATA (SATA) Veri Kablosu (İsteğe Bağlı)
- 1 x I/O Panel Kalkanı

1.2 Özellikler

Platform

- Mini-ITX Form Faktörü
- Tam Katı Bağlayıcı tasarımı

CPU

- 4ncü Nesil Intel® Core™ i7 / i5 / i3 / Xeon® / Pentium® / Celeron®, LGA1150 Paketinde desteklemektedir
- 4 Güç Safhası Tasarımı
- Intel® Turbo Boost 2.0 Teknolojisini destekler

Yonga kümesi

- Intel® H81

Bellek

- Çift Kanallı DDR3 Bellek Teknolojisi
- 2 x DDR3 DIMM yuvaları
- DDR3 1600/1333/1066 ECC olmayan, ara belleğe alınmamış belleği destekler
- Maksimum sistem belleği kapasitesi: 16GB (bkz. DİKKAT)
- Intel® Üstün Bellek Profili (XMP)1.3/1.2 özelliğini destekler

Genişletme Yuvası

- 1 x PCI Express 2.0 x16 yuva

Grafikler

- Intel® HD Graphics Dahili Görselleri ile VGA çıktıları, yalnızca GPU entegre edilmiş işlemciler ile desteklenir.
- Intel® HD Graphics Dahili Görsellerini destekler : AVC, MVC (S3D) ve MPEG-2 Full HW Encode1, Intel® InTru™ 3D, Intel® Net Video HD Teknolojisi, Intel® Insider™, Intel® HD Graphics 4400/4600 ile Intel® Quick Sync Video
- Pixel Shader 5.0, DirectX 11.1
- Maksimum paylaşılan bellek 1792MB
- Üç VGA Çıktısı seçeneği: D-sub, DVI-D ve HDMI
- 1920x1200 @ 60Hz'ye kadar çözünürlükte HDMI Teknolojisini destekler
- 1920x1200 @ 60Hz'ye kadar DVI-D işlevini destekler

- 1920x1200 @ 60Hz'ye kadar çözünürlükle D-Sub işlevini destekler
- HDMI ile Otomatik Dudak Senkronizasyonu (12bpc, xvYCC ve HBR (Yüksek Bit Hızında Ses) özelliklerini destekler (Uyumlu bir HDMI monitörü kullanılmalıdır)
- DVI-D ve HDMI bağlantı noktaları ile HDCP işlevini destekler
- DVI-D, ve HDMI bağlantı noktalarıyla, Full HD 1080p Blu-ray (BD) kayıttan yürütme özelliklerini destekler

Ses

- İçerik Koruma Özelliği ile 7.1 CH HD Ses (Realtek ALC892 Ses Codec Bileşeni)
- Üstün Blu-ray ses desteği

LAN

- PCIE x1 Gigabit LAN 10/100/1000 Mb/s
- Qualcomm® Atheros® AR8171
- Qualcomm® Atheros® Güvenli İnternet Açışı Teknolojisini destekler
- LAN Açılışını Destekler
- Enerji Verimliliğine Sahip Ethernet 802,3az işlevini destekler
- PXE özelliğini destekler

Arka Panel I/O

- 1 x PS/2 Fare/Klavye Portu
- 1 x D-Sub Bağlantı Noktası
- 1 x DVI-D Bağlantı Noktası
- 1 x HDMI Bağlantı Noktası
- 1 x Optik SPDIF Çıkışı Bağlantı Noktası
- 1 x eSATA Bağlayıcısı
- 4 x USB 2.0 Bağlantı noktası
- 2 x USB 3.0 Bağlantı noktası
- LED'e sahip 1 x RJ-45 LAN Bağlantı Noktası (ACT/LINK LED ve SPEED LED)
- HD Ses Jakı: Arka Hoparlör / Merkezi / Bas / Hat Girişi / Ön Hoparlör / Mikrofon

Depolama

- 2 x SATA3 6,0 Gb/s bařlayıcıları, NCQ, AHCI ve Hot Plug işlevlerini destekler
- 1 x eSATA bařlayıcısı, NCQ, AHCI ve Hot Plug işlevlerini destekler

Bařlayıcı

- 1 x Kasa Yetkisiz Eriřim bařlantısı
- 1 x TPM bařlantısı
- 1 x CPU Fan bařlayıcısı (4-pin)
- 1 x Kasa Fanı bařlayıcısı (4-pin)
- 1 x 24 pin ATX güç bařlayıcısı
- 1 x 4 pin 12V güç bařlayıcısı
- 1 x Ön panel ses bařlayıcısı
- 1 x USB 2.0 bařlantısı (2 USB 2.0 bařlantı noktasını destekler)

BIOS Özellięi

- Çok dilli GUI Desteęi ile 32Mb AMI UEFI Legal BIOS
- ACPI 1.1 Uyumluluęu Uyandırma Olayları
- SMBIOS 2.3.1 Desteęi
- CPU, DRAM, PCH 1,05V, PCH 1,5V Voltaj Çoklu Ayarı

Destek CD'si

- Sürücüler, Yardımcı Yazılımlar, AntiVirüs Yazılımı (Deneme Sürümü), CyberLink MediaEspresso 6.5 Deneme Sürümü, Google Chrome Tarayıcı ve Araç Çubuęu, Start8 (30 günlük deneme)

**Donanım
Monitörü**

- CPU/Kasa Sıcaklıęı Tespiti
- CPU/Kasa Devirölçer
- CPU/Kasa Sessiz Fan (Kasa Fan Hızının CPU Sıcaklıęına Göre Otomatik olarak Ayarlanmasını Saęlar)
- CPU/Kasa Fanı Çoklu Hız Kontrolü
- KASA AÇIK algılaması
- Voltaj İzleme: +12V, +5V, +3,3V, CPU Vcore

OS

- Microsoft® Windows® 8 / 8 64-bit / 7 / 7 64-bit ile uyumlu

Belgeler

- FCC, CE, WHQL
- ErP/EuP için hazır (ErP/EuP için hazır güç beslemesi gereklidir)

* Detaylı ürün bilgisi için, lütfen web sitemizi ziyaret edin: <http://www.asrock.com>



Sınırlamalar nedeniyle, gerçek bellek boyutu Windows® 32-bit işletim sistemleri çerçevesinde sistem kullanımına ayrıldığı için 4GB'den az olabilir. Windows® 64-bit işletim sistemlerinde bu tür sınırlamalar yoktur. Windows® tarafından kullanılmayan bellekten faydalanmak için ASRock XFast RAM'i kullanabilirsiniz.

1.3 Bağlantı Teli Kurulumu

Çizim, bağlantı tellerinin kurulumunu göstermektedir. Tel kapağı, pimlerin üzerine yerleştirildiğinde, tel "Kısa" olur. Pimlerin üzerinde tel kapağı bulunmadığında, tel "Kısa" olur. Çizim, pin1 ve pin2 alanları "Kısa" olan ve bu iki pim üzerinde bir bağlantı teli kapağı bulunan 3-pin bağlantı telini göstermektedir.

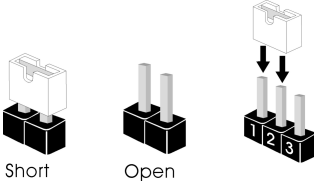

CMOS'u Temizle Bağlantı
Teli
*(CLRCMOS1)
(bkz. sf.1, No. 3)



CLRCMOS1, CMOS verilerini temizlememizi sağlar. Sistem parametrelerini temizlemek ve varsayılan kurulum ayarlarına sıfırlamak için, lütfen bilgisayarı kapatın ve güç kablosunu güç beslemesinden çekin. 15 saniye bekledikten sonra, CLRCMOS1 üzerindeki pin2 ve pin3'ü 5 saniye boyunca kısaltmak için bir bağlantı teli kullanın. Ancak, CMOS'u lütfen BIOS'u güncelledikten hemen sonra temizlemeyin. BIOS'u güncelledikten hemen sonra CMOS'u temizlemeniz gerekirse, önce sistemi başlatın ve ardından CMOS temizleme işlemi öncesinde yeniden kapatın. Lütfen, parola, tarih, saat ve varsayılan kullanıcı profilinin yalnızca CMOS bataryası çıkarıldığında temizleneceğini unutmayın.



CMOS'u temizlerseniz, kasa açık uyarısı alabilirsiniz. Önceki kasa yetkisiz erişim durumu kaydını silmek için lütfen BIOS durumunu "Durumu Temizle" olarak belirleyin.

1.4 Ekli Bağlantılar ve Bağlayıcılar



Ekli bağlantılar ve bağlayıcılar bağlantı teli değildir. Bağlantı teli kapaklarını bu bağlantı ve bağlayıcılar üzerine yerleştirmeyin. Bağlantı teli kapaklarının bağlantılar ile bağlayıcılar üzerine yerleştirilmesi, anakarta kalıcı hasar verebilir.

Sistem Paneli Bağlantısı
(9-pin PANEL1)
(bkz sf.1, No. 8)

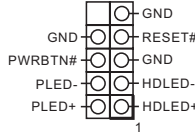

Güç anahtarını bağlayın, kasa üzerindeki anahtar ile sistem durumu belirtecini aşağıdaki pim düzenine göre sıfırlayın. Kabloları bağlarken pozitif ve negatif pimleri not edin.



PWRBTN (Güç Anahtarı):

Güç anahtarını kasa ön paneline bağlayın. Güç anahtarını kullanarak sistemin hangi yöne hareketle kapanacağını seçebilirsiniz.

RESET (Sıfırlama Anahtarı):

Sıfırlama anahtarını kasa ön paneline bağlayın. Bilgisayarın kilitlenmesi ve normal şekilde yeniden başlatılmaması halinde reset (sıfırla) düğmesine basın.

PLED (Sistem Güç LED'i):

Güç durumu göstergesini kasa ön paneline bağlayın. Sistem çalışırken LED ışığı yanacaktır. Sistem S1/S3 uykulu durumda LED ışığı yanıp söner. Sistem S4 uykulu durumunda ya da kapalıyken (S5) LED ışık kapanır.

HDLED (Sabit Disk Etkinlik LED'i):

Sabit sürücü etkinlik LED'ini kasa ön paneline bağlayın. Sabit sürücü veri okur ya da yazarken LED ışığı yanar.

Ön panel tasarımı kasaya göre değişiklik gösterebilir. Bir ön panel modülü, temel olarak bir güç anahtarı, sıfırlama anahtarı, güç LED'i, sabit sürücü aktivitesi LED'i, hoparlör gibi birimlerden oluşur. Kasanızın ön panel modülünü bu bağlantıya takmadan önce, kablo düzenlemeleri ile pin düzenlemelerinin düzgün şekilde yapıldığından emin olun.

Seri ATA3 Bağlayıcıları

(SATA3_0:

bkz. s.1, No. 9)

(SATA3_1:

bkz. s.1, No. 10)



Bu iki SATA3 bağlayıcısı, veri aktarım hızı 6,0 Gb/sn'ye kadar olan dahili depolama aygıtları için tasarlanmış SATA veri kablolarını destekler.

USB 2.0 Bağlantıları

(9-pin USB10_11)

(bkz. sf.1, No. 8)

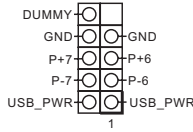

Bu anakart üzerinde, I/O paneli üzerindeki iki USB 2.0 bağlantı noktasının yanı sıra, bir adet bağlantı bulunmaktadır. Her USB 2.0 bağlantısı, iki adet bağlantı noktasını destekleyebilir.

Ön Panel Ses Bağlantısı

(9-pin HD_AUDIO1)

(bkz. sf.1, No. 16)

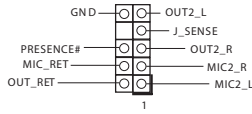

Bu bağlantı, ses aygıtlarının ön ses paneline bağlanması içindir.



1. Yüksek Tanımlı Ses, Jak Algılama özelliğini destekler, ancak bu işlevin düzgün çalışabilmesi için kasa üzerindeki panel kablosunun HDA işlevini desteklemesi gerekmektedir. Sisteminizi kurarken, lütfen kılavuzumuzdaki talimatlar ile kasa kılavuzundaki talimatları izleyin.
2. AC'97 ses paneli kullanıyorsanız, lütfen aşağıdaki adımları uygulayarak ön panel ses bağlantısına takın:
 - A. Mic_IN'i (MIC) MIC2_L'ye bağlayın.
 - B. Audio_R'yi (RIN) OUT2_R'ye ve Audio_L'yi (LIN) OUT2_L'ye bağlayın.
 - C. Toprak'ı (GND) Toprak'a (GND) bağlayın.
 - D. MIC_RET ve OUT_RET yalnızca HD ses paneli içindir. AC'97 ses paneli için bunları bağlamanıza gerek yoktur.
 - E. Ön mikrofonu etkinleştirmek için, Realtek Kontrol panelinde "FrontMic" sekmesine gidin ve "Kayıt Ses Seviyesi"ni ayarlayın.

Kasa Fanı Konektörü
(4-pin CHA_FAN1)
(bkz sf.1, No. 11)

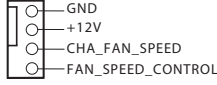

Lütfen fan kablosunu fan konektörüne takın ve siyah teli topraklama pinine bağlayın.

CPU Fan Bağlayıcısı
(4-pin CPU_FAN1)
(bkz sf.1, No. 6)

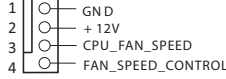

Bu anakart, 4-Pin CPU fan (Sessiz Fan) bağlayıcısı sağlamaktadır. 3-Pin CPU fan bağlamak istiyorsanız, lütfen Pin 1-3'ü kullanın.

ATX Güç Bağlayıcısı
(24-pin ATXPWR1)
(bkz. sf.1, No. 5)

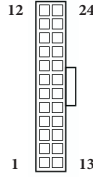

Bu anakart, 24-pin ATX güç bağlayıcısı sağlamaktadır. 20-pin ATX güç beslemesi kullanmak için, lütfen Pin 1 ve Pin13'e bağlayın.

ATX 12V Güç Bağlayıcısı
(8-pin ATX12V1)
(bkz. sf.1, No. 1)



Bu anakart, 8-pin ATX 12V güç bağlayıcısı sağlamaktadır. 4-pin ATX güç beslemesi kullanmak için, lütfen Pin 1 ve Pin13'e bağlayın.

Kasa Yetkisiz Erişim
Bağlantısı
(2-pin C11)
(bkz. sf.1, No. 4)



Bu anakartın kasa kapağının açılıp açılmadığını tespit eden bir KASA AÇIK özelliği bulunmaktadır. Bu özelliğin kullanılabilmesi için kasa yetkisiz erişim tasarımına sahip bir kasa kullanılmalıdır.

TPM Bağlantısı
(17-pin TPMS1)
(bkz. sf.1, No. 12)

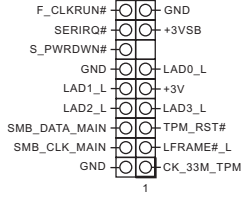

Bu bağlayıcı, anahtarlar, dijital sertifikalar, parolalar ve verileri güvenli bir şekilde saklama özelliği bulunan Güvenilir Platform Modülü (TPM) sistemini destekler. TPM sistemleri, aynı zamanda ağ güvenliğinin artırılması, dijital kimliklerin korunması ve platform bütünlüğünün sağlanmasına da yardımcıdır.

1 개요

ASRock H81M-ITX 마더보드를 구입해 주셔서 감사합니다. 이 마더보드는 ASRock의 일관되고 엄격한 품질관리 하에 생산되어 신뢰성이 우수하며, 품질과 내구성에 대한 ASRock의 기준에 부합하는 우수한 성능과 견고한 설계를 제공합니다.



마더보드 규격과 BIOS 소프트웨어를 업데이트할 수도 있기 때문에, 이 문서의 내용은 예고 없이 변경될 수 있습니다. 이 설명서가 변경될 경우, 업데이트된 버전은 ASRock의 웹사이트에서 추가 통지 없이 제공됩니다. 이 마더보드와 관련하여 기술적 지원이 필요한 경우, 당사의 웹사이트를 방문하여 사용 중인 모델에 대한 구체적 정보를 구하십시오. ASRock의 웹사이트에서는 최신 VGA 카드와 CPU 지원 목록도 찾을 수 있습니다. ASRock 웹사이트 <http://www.asrock.com>.

1.1 포장 내용물

- ASRock H81M-ITX 마더보드 (Mini-ITX 폼팩터)
- ASRock H81M-ITX 간편 설치 안내서
- ASRock H81M-ITX 지원 CD
- 시리얼 ATA (SATA) 데이터 케이블 2 개 (선택 품목)
- I/O 패널 실드 1 개

1.2 규격

플랫폼

- Mini-ITX 폼 팩터
- 모든 솔리드 콘텐서 구조

CPU

- LGA1150 패키지로 제공되는 4 세대 Intel® Core™ i7 / i5 / i3 / Xeon® / Pentium® / Celeron® 지원
- 4 개 전원 위상 구조
- Intel® Turbo Boost 2.0 기술 지원

칩셋

- Intel® H81

메모리

- 듀얼 채널 DDR3 메모리 기술
- DDR3 DIMM 슬롯 2 개
- DDR3 1600/1333/1066 비 -ECC, 비버퍼링 메모리 지원
- 시스템 메모리 최대 용량 : 16GB
(주의 참조)
- Intel® Extreme Memory Profile (XMP) 1.3/1.2 지원

확장 슬롯

- PCI Express 2.0 x16 슬롯 1 개

그래픽

- Intel® HD 그래픽스 빌트 - 인 비주얼과 VGA 출력은 GPU 통합 프로세서로만 지원할 수 있습니다 .
- Intel® HD 그래픽스 빌트 - 인 비주얼 지원 : AVC, MVC (S3D) 및 MPEG-2 풀 HW Encode1 지원 Intel® Quick Sync Video, Intel® InTru™ 3D, Intel® 클리어 비디오 HD 기술 , Intel® Insider™, Intel® HD 그래픽스 4400/4600
- Pixel Shader 5.0, DirectX 11.1
- 최대 공유 메모리 1792MB
- VGA 출력 옵션 세 개 : D-Sub, DVI-D 및 HDMI
- 상중 모니터 지원
- HDMI 기술 지원 (최대 해상도 1920x1200 @ 60Hz)
- DVI-D 지원 (최대 해상도 1920x1200 @ 60Hz)
- D-Sub 지원 (최대 해상도 1920x1200 @ 60Hz)
- Auto Lip Sync, Deep Color (12bpc), xvYCC 및 HBR (High Bit Rate Audio)(HDMI 포함) 지원 (HDMI 호환 모니터 필요)
- DVI-D 및 HDMI 포트를 이용한 HDCP 기능 지원
- DVI-D 및 HDMI 포트를 이용한 Full HD 1080p Blu-ray (BD) 재생 지원

오디오

- 콘텐츠 보호를 이용한 7.1 CH HD 오디오 지원 (Realtek ALC892 오디오 코덱)
- 프리미엄 Blu-ray 오디오 지원

LAN

- PCIE 1 개 , Gigabit LAN 10/100/1000 Mb/s
- Qualcomm® Atheros® AR8171
- Qualcomm® Atheros® 보안 웨이크 온 인터넷 기술 지원
- Wake-On-LAN 지원
- 절전형 이더넷 802.3az 지원
- PXE 지원

- 후면 패널 I/O
- 1 개 PS/2 마우스 / 키보드 포트
 - D-Sub 포트 1 개
 - DVI-D 포트 1 개
 - HDMI 포트 1 개
 - 광학 SPDIF 출력 포트 1 개
 - eSATA 커넥터 1 개
 - USB 2.0 포트 4 개
 - USB 2 포트 3.0 개
 - LED 장착 RJ-45 LAN 포트 1 개 (ACT/LINK LED 및 SPEED LED)
 - HD 오디오 잭 : 후면 스피커 / 중앙 / 베이스 / 라인 입력 / 전면 스피커 / 마이크

- 저장 장치
- SATA3 6.0 Gb/s 커넥터 2 개 , NCQ, AHCI 및 “ 핫 플러그 ” 기능 지원
 - eSATA 커넥터 1 개 , NCQ, AHCI 및 핫 플러그 기능 지원

- 커넥터
- 새시 침입 헤더 1 개
 - TPM 헤더 1 개
 - CPU 팬 커넥터 1 개 (4 핀)
 - 새시 팬 커넥터 1 개 (4 핀)
 - 24 핀 ATX 전원 커넥터 1 개
 - 4 핀 12V 전원 커넥터 1 개
 - 전면 패널 오디오 커넥터 1 개
 - USB 2.0 헤더 1 개 (USB 2.0 포트 2 개 지원)

- BIOS 기능
- 다국어 GUI 지원을 제공하는 32Mb AMI UEFI 적합형 BIOS
 - ACPI 1.1 준수 웨이크 업 이벤트
 - SMBIOS 2.3.1 지원
 - CPU, DRAM, PCH 1,05V, PCH 1,5V 전압 다중 조정

지원 CD

- 드라이버 , 유틸리티 , 백신 소프트웨어 (시험판) ,

* 자세한 제품 정보에 대해서는 당사 웹사이트를 참조하십시오 : <http://www.asrock.com>
 CyberLink MediaEspresso 6.5 시험판 , Google Chrome 브라우저 및 울바 , Start8 (30 일 시험판)



제한 때문에 실제 메모리 크기는 Windows® 32 비트 운영체제 하의 시스템 사용을 위한 예비 메모리용 4GB 보다 더 적을 수 있습니다 . Windows® 64 비트 운영체제에는 그러한 제한이 없습니다 . ASRock XFast RAM 을 사용하여 Windows® 가 사용할 수 없는 메모리를 이용할 수 있습니다 .

- 케이스 열림 감지
- 전압 모니터링 : +12V, +5V, +3.3V, CPU Vcore

OS

- Microsoft® Windows® 8 / 8 64 비트 / 7 / 7 64 비트 호환

인증

- FCC, CE, WHQL
- ErP/EuP 사용 가능 (ErP/EuP 사용 가능 전원공급장치 필요)

1.3 점퍼 설정

그림은 점퍼를 어떻게 설정하는지 보여줍니다. 점퍼 캡을 핀에 씌우면 점퍼가 “단락”됩니다. 점퍼 캡을 핀에 씌우지 않으면 점퍼가 “단선”됩니다. 그림은 3 핀 점퍼를 보여주며 핀 1 과 핀 2 는 점퍼 캡을 씌울 때 “단락”됩니다.

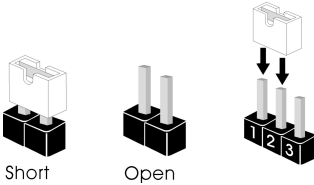

Clear CMOS 점퍼

(CLR CMOS1)

(1 페이지, 3 번 항목 참조)



기본값



Clear CMOS

CLRCMOS1 을 사용하여 CMOS 에 저장된 데이터를 지울 수 있습니다. 시스템 파라미터를 지우고 기본 설정으로 초기화하려면 컴퓨터를 끄고 전원 코드를 전원공급장치에서 빼십시오. 15 초 동안 기다린 후 점퍼 캡을 사용하여 CLRCMOS1 의 핀 2 와 핀 3 을 5 초 동안 단락시키십시오. 그러나 BIOS 업데이트 직후에는 CMOS 를 삭제하지 마십시오. BIOS 업데이트를 완료한 직후 CMOS 를 지워야 할 경우, 우선 시스템을 부팅한 후 바이오스 업데이트를 종료한 다음 CMOS 지우기 작업을 해야 합니다. CMOS 배터리를 제거할 경우에만 암호, 날짜, 시간, 사용자 기본 프로파일이 지워집니다.



CMOS 를 지울 경우 케이스 열림이 감지될 수도 있습니다. BIOS 옵션 “Clear Status(상태 지우기)”를 조절하여 이전의 새시 침입 상태에 대한 기록을 지우십시오.

1.4 온보드 헤더 및 커넥터



온보드 헤더와 커넥터는 점퍼가 아닙니다. 점퍼 캡을 온보드 헤더와 커넥터에 씌우지 마십시오. 점퍼 캡을 온보드 헤더와 커넥터에 씌우면 마더보드가 영구적으로 손상됩니다.

시스템 패널 헤더
(9 핀 PANEL1)
(1 페이지, 8 번 항목 참조)

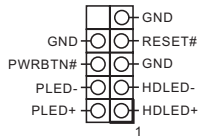

새시의 전원 스위치, 리셋 스위치, 시스템 상태 표시등을 아래의 핀 할당에 따라 이 헤더에 연결합니다. 케이블을 연결하기 전에 양극 핀과 음극 핀을 기록합니다.



PWRBTN(전원 스위치):

새시 전면 패널의 전원 스위치에 연결합니다. 전원 스위치를 이용해 시스템을 끄는 방법을 구성할 수 있습니다.

RESET(리셋 스위치):

새시 전면 패널의 리셋 스위치에 연결합니다. 컴퓨터가 정지하고 정상적 재시작을 수행하지 못할 경우 리셋 스위치를 눌러 컴퓨터를 재시작합니다.

PLED(시스템 전원 LED):

새시 전면 패널의 전원 상태 표시등에 연결합니다. 시스템이 작동하고 있을 때는 LED 가 켜져 있습니다. 시스템이 S1/S3 대기 상태에 있을 때는 LED 가 계속 깜박입니다. 시스템이 S4 대기 상태 또는 전원 꺼짐 (S5) 상태에 있을 때는 LED 가 꺼져 있습니다.

HDLED(하드 드라이브 동작 LED):

새시 전면 패널의 하드 드라이브 동작 LED 에 연결합니다. 하드 드라이브가 데이터를 읽거나 쓰고 있을 때 LED 가 켜져 있습니다.

전면 패널 디자인은 새시별로 다를 수 있습니다. 전면 패널 모듈은 주로 전원 스위치, 리셋 스위치, 전원 LED, 하드 드라이브 동작 LED, 스피커 등으로 구성되어 있습니다. 새시 전면 패널 모듈을 이 헤더에 연결할 때 와이어 할당과 핀 할당이 정확히 일치하는지 확인합니다.

시리얼 ATA3 커넥터
(SATA3_0:
1 페이지, 9 번 항목 참조)
(SATA3_1:
1 페이지, 10 번 항목 참조)



이들 두 SATA3 커넥터는 최대 6.0 Gb/s 데이터 전송 속도를 제공하는 내부 저장 장치용 SATA 데이터 케이블을 지원합니다.

USB 2.0 헤더
(9 핀 USB10_11)
(1 페이지, 8 번 항목 참조)

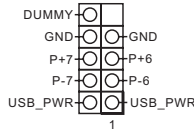

I/O 패널에 USB 2.0 포트 두 개가 탑재되어 있을 뿐 아니라 마더보드에 헤더 한 개가 탑재되어 있습니다. 각 USB 2.0 헤더는 포트 두 개를 지원할 수 있습니다.

전면 패널 오디오 헤더
(9 핀 HD_AUDIO1)
(1 페이지, 16 번 항목 참조)

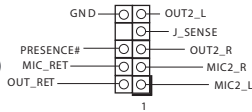

이 헤더는 오디오 장치를 전면 오디오 패널에 연결하는 데 사용됩니다.



1. 고음질 오디오는 잭 감지를 지원하지만 올바르게 작동하려면 새시의 패널 와이어가 HDA를 지원해야 합니다. 설명서 및 새시 설명서에 나와 있는 지침을 따라 시스템을 설치하십시오.
2. AC'97 오디오 패널을 사용할 경우 아래와 같은 절차를 따라 전면 패널 오디오 헤더에 설치하십시오:
 - A. Mic_IN (MIC)를 MIC2_L에 연결합니다.
 - B. Audio_R (RIN)을 OUT2_R에 연결하고 Audio_L (LIN)을 OUT2_L에 연결합니다.
 - C. 접지 (GND)를 접지 (GND)에 연결합니다.
 - D. MIC_RET 및 OUT_RET는 HD 오디오 패널에만 사용됩니다. AC'97 오디오 패널용으로 연결할 필요가 없습니다.
 - E. 전면 마이크를 활성화하려면 Realtek 제어판에서 "FrontMic" 탭으로 가서 "Recording Volume(녹음 볼륨)"을 조정합니다.

새시 팬 커넥터
(4 핀 CHA_FAN1)
(1 페이지, 11 번 항목 참조)

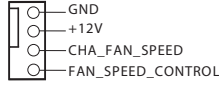

팬 케이블을 팬 커넥터에 연결하고 검은색 와이어를 접지핀에 연결하십시오.

CPU 팬 커넥터
(4 핀 CPU_FAN1)
(1 페이지, 6 번 항목 참조)

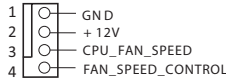

이 마더보드에는 4 핀 CPU 팬 (저소음 팬) 커넥터가 탑재되어 있습니다. 3 핀 CPU 팬을 연결하려는 경우 핀 1-3 에 연결하십시오.

ATX 전원 커넥터
(24 핀 ATXPWR1)
(1 페이지, 5 번 항목 참조)

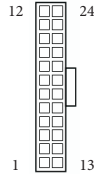

이 마더보드에는 24 핀 ATX 전원 커넥터가 탑재되어 있습니다. 20 핀 ATX 전원공급장치를 사용하려면 핀 1 과 핀 13 을 따라 연결하십시오.

ATX 12V 전원 커넥터
(8 핀 ATX12V1)
(1 페이지, 1 번 항목 참조)



이 마더보드에는 8 핀 ATX 12V 전원 커넥터가 탑재되어 있습니다. 4 핀 ATX 전원공급장치를 사용하려면 핀 1 과 핀 5 을 따라 연결하십시오.

새시 침입 헤더
(2 핀 CII)
(1 페이지, 4 번 항목 참조)



이 마더보드는 새시 커버가 제거될 경우 이를 감지하는 케이스 열림 감지 기능을 지원합니다. 이 기능을 사용하려면 새시 침입 감지 설계가 적용된 새시를 사용해야 합니다.

TPM 헤더
 (17 핀 TPMS1)
 (1 페이지, 12 번 항목 참조)

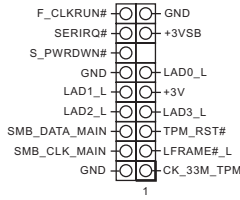

이 커넥터는 키, 디지털 인증서, 암호 및 데이터를 안전하게 보관할 수 있는 TPM(Trusted Platform Module) 시스템을 지원합니다. TPM 시스템은 네트워크 보안을 강화하고, 디지털 신원을 보호하며 플랫폼 무결성을 유지합니다.

1 はじめに

アスロックの一貫した厳格な品質管理の下で製造された信頼性の高いマザーボードであるアスロック H81M-ITX マザーボードをお買い上げいただきありがとうございます。アスロックの品質と耐久性の取り組みに準拠した堅牢な設計を持つ、優れたパフォーマンスを提供します。



マザーボードの仕様と BIOS ソフトウェアは更新されることがあるため、このマニュアルの内容は予告なしに変更することがあります。このマニュアルの内容に変更があった場合には、更新されたバージョンは、予告なくアスロックのウェブサイトから入手できるようになります。このマザーボードに関する技術的なサポートが必要な場合には、ご使用のモデルについての詳細情報を、当社のウェブサイトで参照ください。アスロックのウェブサイトでは、最新の VGA カードおよび CPU サポート一覧もご覧になれます。アスロックウェブサイト <http://www.asrock.com>。

1.1 パッケージの内容

- アスロック H81M-ITX マザーボード(ミニ ITX フォームファクター)
- アスロック H81M-ITX クイックインストールガイド
- アスロック H81M-ITX サポート CD
- 2 x シリアル ATA (SATA) データケーブル(オプション)
- 1 x I/O パネルシールド

1.2 仕様

- プラットフォーム**
- ミニ ITX フォームファクター
 - オール固体コンデンサ設計

- CPU**
- LGA1150 パッケージでは第 4 世代の Intel® Core™ i7 / i5 / i3 / Xeon® / Pentium® / Celeron® をサポート
 - 4 電源フェーズ設計
 - Intel® ターボブースト 2.0 テクノロジーをサポート

- チップセット**
- Intel® H81

- メモリ**
- デュアルチャンネル DDR3 メモリテクノロジー
 - 2 x DDR3 DIMM スロット
 - DDR3 1600/1333/1066 ECC なし、アンバッファードメモリをサポート
 - システムメモリの最大容量: 16GB (注意を参照)
 - Intel® エクストリームメモリプロファイル (XMP) 1.3/1.2 をサポート

- 拡張スロット**
- 1 x PCI Express 2.0 x16 スロット

- グラフィックス**
- Intel® HD グラフィックス内蔵ビジュアルおよび VGA 出力は、GPU に統合されたプロセッサのみでサポートされます。
 - Intel® HD グラフィックス内蔵ビジュアルをサポート: AVC、MVC (S3D)、MPEG-2 フル HW エンコード 1 の Intel® Quick Sync Video、Intel® InTru™ 3D、Intel® クリアビデオ HD テクノロジー、Intel® インサイダー™、Intel® HD グラフィックス 4400/4600
 - ピクセルシェーダー 5.0、DirectX 11.1
 - 最大共有メモリ 1792MB
 - 3 つの VGA 出力オプション: D-Sub、DVI-D、HDMI
 - HDMI テクノロジーをサポート。最大解像度 1920x1200 @60Hz
 - DVI-D をサポート。最大解像度 1920x1200 @60Hz

- D-Sub をサポート。最大解像度 1920x1200 @60Hz
- HDMI (HDMI 準拠のモニターが必要) では、オートリッパシंक、ディープカラー (12bpc)、xvYCC、HBR (高ビットレートオーディオ) をサポート
- DVI-D と HDMI ポートで、HDCP 機能をサポート
- DVI-D と HDMI ポートで、フル HD 1080p ブルーレイ (BD) 再生をサポート

音声

- 7.1 CH HD オーディオ、コンテンツプロテクション付き (Realtek ALC892 オーディオコーデック)
- プレミアムブルーレイオーディオサポート

LAN

- PCIe x1 ギガビット LAN 10/100/1000 Mb/ 秒
- クアルコム® アセロス® AR8171
- クアルコム® アセロス® セキュリティウェイクオンインター ネットテクノロジーをサポート
- ウェイクオンランをサポート
- エネルギー効率のよいイーサネット 802.3az をサポート
- PXE をサポート

リアパネル I/O

- PS/2 マウス / キーボードポート x 1
- 1 x D-Sub ポート
- 1 x DVI-D ポート
- 1 x HDMI ポート
- 1 x 光 SPDIF 出力ポート
- 1 x eSATA コネクタ
- 4 x USB 2.0 ポート
- 2 x USB 3.0 ポート
- LED 付き 1 x RJ-45 LAN ポート (ACT/LINK LED と SPEED LED)
- HD オーディオジャック: リアスピーカー / センター / バス / ラインイン / フロントスピーカー / マイク

ストレージ

- 2 x SATA3 6.0 Gb/ 秒コネクタ、NCQ、AHCI、ホットプラグ機能をサポート
- 1 x eSATA コネクタ、NCQ、AHCI、ホットプラグ機能をサポート

コネクタ

- 1 x シャーシインテリジョンヘッダー
- 1 x TPM ヘッダー
- 1 x CPU ファンコネクタ(4 ピン)
- 1 x シャーシファンコネクタ(4 ピン)
- 1 x 24 ピン ATX 電源コネクタ
- 1 x 4 ピン 12V 電源コネクタ
- 1 x 前面パネルオーディオコネクタ
- 1 x USB 2.0 ヘッダー(2 つの USB 2.0 ポートをサポート)

BIOS 機能

- 多言語 GUI サポート付きの 32Mb AMI UEFI Legal BIOS
- ACPI 1.1 準拠のウェイクアップイベント
- SMBIOS 2.3.1 をサポート
- CPU、DRAM、PCH 1.05V、PCH 1.5V 複数電圧設定

サポート CD

- ドライバー、ユーティリティ、アンチウイルスソフトウェア (トライアル版)、CyberLink MediaEspresso 6.5 トライアル、Google Chrome ブラウザー、ツールバー、Start8 (30 日トライアル版)

ハードウェアモニター

- CPU/ シャーシ温度センサー
- CPU / シャーシタコメーター
- CPU/ シャーシ静音ファン (CPU 温度によるシャーシファン速度の自動調整可能)
- CPU/ シャーシファンマルチ速度制御
- ケース開閉検知
- 電圧監視: +12V、+5V、+3.3V、CPU Vcore

OS

- Microsoft® Windows® 8 / 8 64 ビット / 7 / 7 64 ビット準拠

認証

- FCC、CE、WHQL
- ErP/EuP Ready (ErP/EuP ready 電源が必要です)

* 商品詳細については、当社ウェブサイトをご覧ください。<http://www.asrock.com>



Windows® 32 ビットオペレーティングシステムでの、システム使用に割り当てられた実際のメモリサイズは制限のため、4GB 未満のことがあります。Windows® 64 ビットのオペレーティングシステムでは、そのような制限はありません。Windows® では使えないメモリを使用するために、アスロック XFast RAM を使用することができます。

1.3 ジャンパー設定

このイラストは、ジャンパーの設定方法を示しています。ジャンパーキャップがピンに被さっていると、ジャンパーは「ショート」です。ジャンパーキャップがピンに被さっていない場合には、ジャンパーは「オープン」です。この図は3ピンのジャンパーを表し、ジャンパーキャップがピン1とピン2に被さっているとき、これらのピンは「ショート」です。

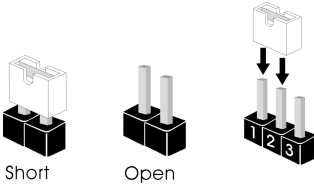

CMOS クリアジャンパー
(CLRCMOS1)
(p.1、No. 3 参照)



CLRCMOS1 は、CMOS のデータをクリアすることができます。クリアして、デフォルト設定にシステムパラメーターをリセットするには、コンピューターの電源を切り、電源から電源コードを抜いてください。15 秒待ってから、CLRCMOS1 のピン2とピン3をジャンパーキャップを使って5秒間ショートします。ただし、BIOS をアップデートした直後に、CMOS をクリアしないでください。BIOS をアップデート後、CMOS をクリアする必要がある場合は、最初にシステムを起動し、それから CMOS クリアアクションを行う前にシャットダウンしてください。パスワード、日付、時間、ユーザーのデフォルトプロファイルは、CMOS の電池を取り外した場合にのみ、消去されることにご注意ください。



CMOS をクリアすると、ケースの開閉が検知されることがあります。以前のシャシインテリジェンスステータス記録を消去するには、BIOS オプションから「Clear Status (ステータスの消去)」で調整してください。

1.4 オンボードのヘッダーとコネクタ



オンボードヘッダーとコネクタはジャンパーではありません。これらヘッダーとコネクタにはジャンパーキャップを被せないでください。ヘッダーおよびコネクタにジャンパーキャップを被せると、マザーボードに永久損傷が起こることがあります。

システムパネルヘッダー
(9ピンパネル 1)
(p.1、No. 8 参照)

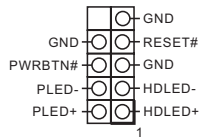

電源スイッチを接続し、スイッチをリセットし、下記のピン割り当てに従って、シャーシのシステムステータス表示ランプをこのヘッダーにセットします。ケーブルを接続するときには、ピンの十と一に気をつけてください。



PWRBTN(電源スイッチ):

シャーシ前面パネルの電源スイッチに接続してください。電源スイッチを使用して、システムをオフにする方法を設定できます。

RESET(リセットスイッチ):

シャーシ前面パネルのリセットスイッチに接続してください。コンピューターがフリーズしたり、通常の再起動を実行できない場合には、リセットスイッチを押して、コンピューターを再起動します。

PLED(システム電源 LED):

シャーシ前面パネルの電源ステータスインジケータに接続してください。システム稼働中は、LED が点灯します。システムが S1/S3 スリープ状態の場合には、LED は点滅を続けます。システムが S4 スリープ状態または電源オフ(S5)のときには、LED はオフです。

HDLED(ハードドライブアクティビティ LED):

シャーシ前面パネルのハードドライブアクティビティ LED に接続してください。ハードドライブのデータを読み取りまたは書き込み中に、LED はオンになります。

前面パネルデザインは、シャーシによって異なることがあります。前面パネルモジュールは、主に電源スイッチ、リセットスイッチ、電源 LED、ハードドライブアクティビティ LED、スピーカーなどから構成されます。シャーシの前面パネルモジュールとこのヘッダーを接続する場合には、配線の割り当てと、ピンの割り当てが正しく合致していることを確かめてください。

シリアル ATA3

コネクタ

(SATA3_0:

p.1、No. 9 参照)

(SATA3_1:

p.1、No. 10 参照)



これら2つのSATA3コネクタは、最高6.0 Gb/秒のデータ転送速度で内部ストレージデバイス用のSATAデータケーブルをサポートします。

USB 2.0 ヘッダー

(9ピン USB10_11)

(p.1、No. 8 参照)

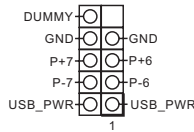

I/Oパネルの2つのUSB 2.0ポートに加えて、このマザーボードには1つのヘッダーがあります。各USB 2.0ヘッダーは、2つのポートをサポートできます。

フロントパネルオーディオヘッダー

(9ピン HD_AUDIO1)

(p.1、No. 16 参照)

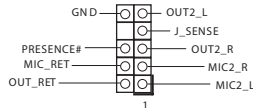

このヘッダーは、フロントオーディオパネルにオーディオデバイスを接続するためのものです。



1. ハイディフィニションオーディオはジャックセンシングをサポートしていますが、正しく機能するためには、シャーシのパネルワイヤーがHDAをサポートしている必要があります。お使いのシステムを取り付けるには、当社のマニュアルおよびシャーシのマニュアルの指示に従ってください。
2. AC'97オーディオパネルを使用する場合には、次のステップで、前面パネルオーディオヘッダーに取り付けてください。
 - A. Mic_IN (MIC) を MIC2_L に接続します。
 - B. Audio_R (RIN) を OUT2_R に、Audio_L (LIN) を OUT2_L に接続します。
 - C. アース (GND) をアース (GND) に接続します。
 - D. MIC_RET と OUT_RET は、HD オーディオパネル専用です。AC'97 オーディオパネルではこれらを接続する必要はありません。
 - E. フロントマイクを有効にするには、Realtekコントロールパネルの「FrontMic」タブで、「録音音量」を調整してください。

シャーシファンコネクタ
(4ピン CHA_FAN1)
(p.1、No. 11 参照)

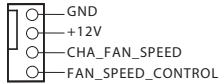

ファンケーブルはファンコネクタに接続し、黒線とアースピンを合わせてください。

CPU ファンコネクタ
(4ピン CPU_FAN1)
(p.1、No. 6 参照)

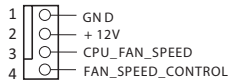

このマザーボードは4ピンCPUファン(静音ファン)コネクタを提供します。3ピンのCPUファンを接続する場合には、ピン1-3に接続してください。

ATX 電源コネクタ
(24ピン ATXPWR1)
(p.1、No. 5 参照)

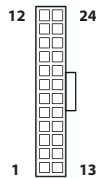

このマザーボードは24ピンATX電源コネクタを提供します。20ピンのATX電源を使用するには、ピン1と13番に合わせて接続してください。

ATX12V 電源コネクタ
(8ピン ATX12V1)
(p.1、No. 1 参照)



このマザーボードは8ピンATX12V電源コネクタを提供します。4ピンのATX電源を使用するには、ピン1と5番に合わせて接続してください。

シャーシイントリ
ュージョンヘッ
ダー
(2ピン CH1)
(p.1、No. 4 参照)



このマザーボードはシャーシカバーが開けられたことを検知する、ケース開閉検知機能をサポートします。この機能には、シャーシイントリュージョン検知設計されたシャーシが必要です。

TPM ヘッダー
(17ピン TPMS1)
(p.1、No. 12 参照)

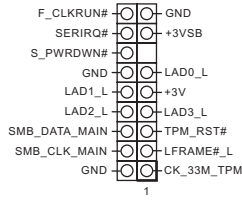

このコネクタはトラステッドプラットフォームモジュール(TPM)システムをサポートし、鍵、デジタル証明書、パスワード、データを安全に保管することができます。TPM システムはまた、ネットワークセキュリティを高め、デジタル証明書を保護し、プラットフォームの完全性を保証します。

1 简介

感谢您购买 ASRock H81M-ITX 主板，这是按照 ASRock 一贯严格质量控制标准生产的性能可靠的主板。它提供符合 ASRock 质量和耐久性承诺的精良设计和卓越性能。



由于主板规格和 BIOS 软件可能已更新，因此，本文档的内容可能会随时更改，恕不另行通知。如果本文档有任何修改，则更新的版本将发布在 ASRock 网站上，我们不会另外进行通知。如果您需要与此主板相关的技术支持，请访问我们的网站以具体了解所用型号的信息。您也可以在 ASRock 网站上找到最新 VGA 卡和 CPU 支持列表。ASRock 网站 <http://www.asrock.com>。

1.1 包装清单

- ASRock H81M-ITX 主板（Mini-ITX 规格尺寸）
- ASRock H81M-ITX 快速安装指南
- ASRock H81M-ITX 支持光盘
- 2 x 串行 ATA (SATA) 数据线（选购）
- 1 x I/O 面板

1.2 规格

平台

- Mini-ITX 规格尺寸
- 全固态电容器设计

CPU

- 支持 LGA1150 封装第 4 代 Intel® Core™ i7 / i5 / i3 / Xeon® / Pentium® / Celeron®
- 4 电源相设计
- 支持 Intel® Turbo Boost 2.0 技术

芯片集

- Intel® H81

内存

- 双通道 DDR3 内存技术
- 2 x DDR3 DIMM 槽
- 支持 DDR3 1600/1333/1066 非 ECC，非缓冲内存
- 支持系统内存容量：16GB（见“注意”）
- 支持 Intel® Extreme Memory Profile (XMP) 1.3/1.2

扩充槽

- 1 x PCI Express 2.0 x16 槽

图形

- 只有 GPU 集成的处理器才支持 Intel® HD Graphics 内置视效和 VGA 输出。
- 支持 Intel® HD Graphics 内置视效：Intel® 快速同步视频，采用 AVC、MVC (S3D) 和 MPEG-2 Full HW Encode1、Intel® InTru™ 3D、Intel® Clear Video HD 技术、Intel® Insider™、Intel® HD Graphics 4400/4600
- Pixel Shader 5.0、DirectX 11.1
- 最大共享内存 1792MB
- 三个 VGA 输出选项：D-Sub、DVI-D 和 HDMI
- 支持 HDMI 技术，60Hz 时最大分辨率达 1920x1200
- 支持 DVI-D，60Hz 时最大分辨率达 1920x1200

- 支持 D-Sub，60Hz 时最大分辨率达 1920x1200
- 通过 HDMI（需要符合规格的 HDMI 监视器）支持 Auto Lip Sync、Deep Color (12bpc)、xvYCC 和 HBR（高位速率音频）
- 通过 DVI-D and HDMI 端口支持 HDCP 功能
- 通过 DVI-D 和 HDMI 端口支持全高清 1080p Blu-ray (BD) 播放。

音频

- 具有内容保护功能的 7.1 CH 高清音频（Realtek ALC892 音频编解码器）
- 优质 Blu-ray 音频支持

LAN

- PCIE x1 Gigabit LAN 10/100/1000 Mb/s
- Qualcomm® Atheros® AR8171
- 支持 Qualcomm® Atheros® 网上安全唤醒技术
- 支持 Wake-On-LAN（网上唤醒）
- 支持高能效以太网 802.3az
- 支持 PXE

后面板 I/O

- 1 个 PS/2 鼠标 / 键盘接口
- 1 x D-Sub 端口
- 1 x DVI-D 端口
- 1 x HDMI 端口
- 1 x 光学 SPDIF 输出端口
- 1 x eSATA 接口
- 4 x USB 2.0 端口
- 2 x USB 3.0 端口
- 1 x RJ-45 LAN 端口，带 LED（ACT/LINK LED 和 SPEED LED）
- 高清音频插孔：后扬声器 / 中央 / 低音 / 线路输入 / 前扬声器 / 麦克风

存储

- 2 x SATA3 6.0 Gb/s 接口，支持 NCQ、AHCI 和热插拔
- 1 x eSATA 接口，支持 NCQ、AHCI 和热插拔

接口

- 1 x 机箱侵入接脚
- 1 x TPM 接脚
- 1 x CPU 风扇接口 (4 针)
- 1 x 机箱风扇接口 (4 针)
- 1 x 24 针 ATX 电源接口
- 1 x 4 针 12V 电源接口
- 1 x 前面板音频接口
- 1 x USB 2.0 接脚 (支持 2 个 USB 2.0 端口)

BIOS 功能特点

- 32Mb AMI UEFI Legal BIOS，具有多语言 GUI 支持
- ACPI 1.1 兼容唤醒事件
- SMBIOS 2.3.1 支持
- CPU、DRAM、PCH 1.05V、PCH 1.5V 电压多次调整 (Voltage Multi-adjustment)

支持光盘

- 驱动程序、实用程序、防病毒软件 (试用版)、CyberLink MediaEspresso 6.5 试用版、Google Chrome 浏览器和工具栏、Start8(30 天试用版)

硬件监控

- CPU/ 机箱温度感测
- CPU/ 机箱转速计
- CPU/ 机箱静音风扇 (可以按照 CPU 温度自动调整机箱风扇速度)
- CPU/ 机箱风扇多种速度控制
- CASE OPEN (机箱打开) 检测
- 电压监控：+12V、+5V、+3.3V、CPU Vcore

操作系统

- Microsoft® Windows® 8 / 8 64-bit / 7 / 7 64-bit 兼容

认证

- FCC、CE、WHQL
- ErP/EuP 支持 (需要支持 ErP/EuP 的电源)

* 有关详细产品信息，请访问我们的网站：<http://www.asrock.com>



由于限制原因，实际内存容量可能会小于 4GB，以保留给 Windows® 32-bit 操作系统下的系统使用。Windows® 64-bit 操作系统没有此类限制。您可以使用 ASRock XFast RAM 来利用 Windows® 不能使用的内存。

1.3 跳线设置

此图显示如何设置跳线。将跳线帽装到这些针脚上时，跳线“短接”。如果这些针脚上没有装跳线帽，跳线“开路”。此图显示 3 针跳线，当跳线帽装在针脚 1 和针脚 2 上，它们“短接”。

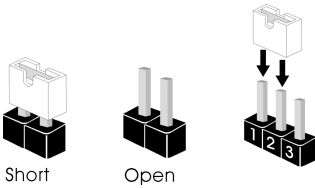

清除 CMOS 跳线

(CLR_CMOS1)

(见第 1 页, 第 3 个)



默认



清除 CMOS

CLR_CMOS1 允许您清除 CMOS 中的数据。要清除和重置系统参数到默认设置，请关闭计算机，从电源上拔下电源线插头。等候 15 秒后，使用跳线帽将 CLR_CMOS1 上的针脚 2 和针脚 3 短接 5 秒。但是，请勿在更新 BIOS 后立即清除 CMOS。如果您需要在刚完成 BIOS 更新后清除 CMOS，则必须先启动系统，并在关闭后再执行清除 CMOS 操作。请注意，密码、日期、时间和用户默认配置文件只在卸下 CMOS 电池后才会被清除。



如果您清除 CMOS，机箱打开会被检测到。请将 BIOS 选项“Clear Status”（清除状态）调整为清除前一个机箱侵入状态的记录。

1.4 板载接脚和接口



板载接脚和接口不是跳线。不要将跳线帽装到这些接脚和接口上。将跳线帽装到这些接脚和接口上将会对主板造成永久性损坏。

系统面板接脚

(9 针 PANEL1)

(见第 1 页，第 8 个)

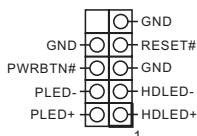

按照下面的针脚分配，将机箱上的电源开关、重置开关和系统状态指示灯连接到此接脚。在连接线缆前请记下正负针脚。



PWRBTN(电源开关) :

连接到机箱前面板上的电源开关。您可以配置使用电源开关关闭系统的方式。

RESET(重置开关) :

连接到机箱前面板上的重置开关。如果计算机死机，无法执行正常重新启动，按重置开关重新启动计算机。

PLED(系统电源 LED) :

连接到机箱前面板上的电源状态指示灯。系统操作操作时，此 LED 亮起。系统处在 S1/S3 睡眠状态时，此 LED 闪烁。系统处在 S4 睡眠状态或关机 (S5) 时，此 LED 熄灭。

HDLED(硬盘活动 LED) :

连接到机箱前面板上的硬盘活动 LED 指示灯。硬盘正在读取或写入数据时，此 LED 亮起。

前面板设计根据机箱不同而有所差异。前面板模块主要包括电源开关、重置开关、电源 LED、硬盘活动 LED 指示灯、扬声器等。将机箱前面板模块连接到此接脚时，确保连线分配和针脚分配正确匹配。

串行 ATA3 接口

(SATA3_0:

见第 1 页, 第 9 个)

(SATA3_1:

见第 1 页, 第 10 个)



这 2 个 SATA3 接口支持最高 6.0 Gb/s 数据传输速率的内部存储设备的 SATA 数据线。

USB 2.0 接口

(9 针 USB10_11)

(见第 1 页, 第 8 个)

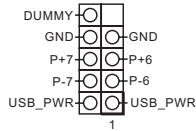

除 I/O 面板上的两个 USB 2.0 端口外, 此主板上还有两个接口。每个 USB 2.0 接口可以支持两个端口。

前面板音频接口

(9 针 HD_AUDIO1)

(见第 1 页, 第 16 个)

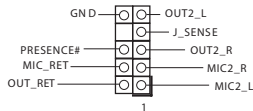

此接口用于将音频设备连接到前音频面板。



1. 高清音频支持插孔感测, 但机箱上的面板连线必须支持 HDA 才能正常工作。请按照我们的手册和机箱手册的说明安装系统。
2. 如果您使用 AC'97 音频面板, 请按照以下步骤将它安装到前面板音频接口:
 - A. 将 Mic_IN (MIC) 连接到 MIC2_L。
 - B. 将 Audio_R (RIN) 连接到 OUT2_R, 将 Audio_L (LIN) 连接到 OUT2_L。
 - C. 将接地端 (GND) 连接到接地端 (GND)。
 - D. MIC_RET 和 OUT_RET 只用于高清音频面板。您不需要针对 AC'97 音频面板连接它们。
 - E. 要启用前麦克风, 请转到 Realtek 控制面板上的“FrontMic” (前麦克风) 选项卡, 调整“Recording Volume” (录音音量)。

机箱风扇接口
(4 针 CHA_FAN1)
(见第 1 页, 第 11 个)

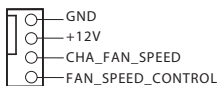

请将风扇线连接到风扇接口并使黑线匹配接地引脚。

CPU 风扇接口
(4 针 CPU_FAN1)
(见第 1 页, 第 6 个)

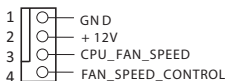

此主板提供 4 针 CPU 风扇 (静音风扇) 接口。如果您打算连接 3 针 CPU 风扇, 请将它连接到引脚 1-3。

ATX 电源接口
(24 针 ATXPWR1)
(见第 1 页, 第 5 个)

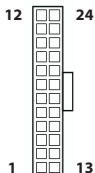

此主板提供 24 针 ATX 电源接口。要使用 20 针 ATX 电源, 请沿引脚 1 和引脚 13 插接它。

ATX 12V 电源接口
(8 针 ATX12V1)
(见第 1 页, 第 1 个)



此主板提供 8 针 ATX 12V 电源接口。要使用 4 针 ATX 电源, 请沿引脚 1 和引脚 5 插接它。

机箱侵入接口 (2 针 CI1)
(见第 1 页, 第 4 个)

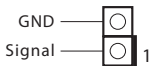

此主板支持 CASE OPEN (机箱打开) 检测功能 - 检测机箱盖是否拆下。此功能需要采用侵入检测设计的机箱。

TPM 接口
(17 针 TPMS1)
(见第 1 页, 第 12 个)

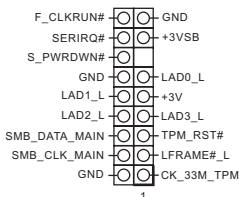

此接口支持 Trusted Platform Module (信任平台模块, TPM) 系统, 可以安全地存储密钥、数字证书、密码和数据。TPM 系统也可以帮助增强网络安全, 保护数字身份和确保平台完整性。

電子信息產品污染控制標示

依据中国发布的「电子信息产品污染控制管理办法」及 SJ/T 11364-2006「电子信息产品污染控制标示要求」，电子信息产品应进行标示，藉以向消费者揭露产品中含有的有毒有害物质或元素不致发生外泄或突变从而对环境造成污染或对人体、财产造成严重损害的期限。依上述规定，您可于本产品之印刷电路板上看见图一之标示。图一中之数字为产品之环保使用期限。由此可知此主板之环保使用期限为 10 年。



图一

有毒有害物質或元素的名稱及含量說明

若您欲了解此产品的有毒有害物质或元素的名称及含量说明，请参照以下表格及说明。

部件名称	有害物质或元素					
	铅 (Pb)	镉 (Cd)	汞 (Hg)	六价铬 (Cr(VI))	多溴联苯 (PBB)	多溴二苯醚 (PBDE)
印刷电路板及电子组件	X	O	O	O	O	O
外部信号连接头及线材	X	O	O	O	O	O

O：表示该有毒有害物质在该部件所有均质材料中的含量均在 SJ/T 11363-2006 标准规定的限量要求以下。

X：表示该有毒有害物质至少在该部件的某一均质材料中的含量超出 SJ/T 11363-2006 标准规定的限量要求，然该部件仍符合欧盟指令 2002/95/EC 的规范。

备注：此产品所标示之环保使用年限，系指在一般正常使用状况下。

1 簡介

感謝您購買 ASRock H81M-ITX 主機板，本主機板經 ASRock 嚴格品質製作，是一套讓人信賴的可靠產品。本產品採耐用設計所展現的優異效能，完全符合 ASRock 對品質及耐用度的承諾。



由於主機板規格及 BIOS 軟體可能會更新，所以本文件內容如有變更，恕不另行通知。如本文件有任何修改，可至 ASRock 網站逕行取得更新版本，不另外通知。若您需要與本主機板相關的技術支援，請上我們的網站瞭解有關您使用機型的特定資訊。您也可以到 ASRock 網站找到最新的 VGA 卡及 CPU 支援清單。ASRock 網站 <http://www.asrock.com>

1.1 包裝內容

- ASRock H81M-ITX 主機板 (Mini-ITX 尺寸)
- ASRock H81M-ITX 快速安裝指南
- ASRock H81M-ITX 支援光碟
- 2 x Serial ATA (SATA) 資料纜線 (選用)
- 1 x I/O 面板外罩

1.2 規格

- 平台**
- Mini-ITX 尺寸
 - 全固態電容設計

- CPU**
- 支援第 4 代 Intel® Core™ i7 / i5 / i3 / Xeon® / Pentium® / Celeron® (LGA1150 封裝)
 - 4 電源相位設計
 - 支援 Intel® Turbo Boost 2.0 技術

- 晶片組**
- Intel® H81

- 記憶體**
- 雙通道 DDR3 記憶體技術
 - 2 x DDR3 DIMM 插槽
 - 支援 DDR3 1600/1333/1066 非 ECC、無緩衝記憶體
 - 最大系統記憶體容量：16GB (請參閱「注意」)
 - 支援 Intel® Extreme Memory Profile (XMP) 1.3/1.2

- 擴充插槽**
- 1 x PCI Express 2.0 x16 插槽

- 顯示卡**
- 僅限整合 GPU 的處理器才可支援 Intel® HD Graphics Built-in Visuals 及 VGA 輸出。
 - 支援 Intel® HD Graphics Built-in Visuals：轉換 AVC、MVC (S3D) 及 MPEG-2 Full HW Encode 的 Intel® 高速影像同步轉檔技術、Intel® InTru™ 3D、Intel® Clear Video HD Technology、Intel® Insider™、Intel® HD Graphics 4400/4600
 - Pixel Shader 5.0，DirectX 11.1
 - 最大共用記憶體 1792MB
 - 三個 VGA 輸出選項：D-Sub、DVI-D 及 HDMI
 - 支援最高達 1920x1200 @ 60Hz 解析度的 HDMI 技術
 - 支援最高達 1920x1200 @ 60Hz 解析度的 DVI-D

- 支援最高達 1920x1200 @ 60Hz 解析度的 D-Sub
- 支援使用 HDMI（需相容於 HDMI 監視器）的 Auto Lip Sync、Deep Color (12bpc)、xvYCC 及 HBR（高位元率音訊）
- 支援含 DVI-D 及 HDMI 連接埠的 HDCP 功能
- 支援透過 DVI-D 及 HDMI 連接埠的 Full HD 1080p Blu-ray (BD) 播放

音訊

- 7.1 CH HD 音訊含內容保護（Realtek ALC892 音訊轉碼器）功能
- 高階藍光音訊支援

LAN

- PCIE x1 Gigabit LAN 10/100/1000 Mb/s
- Qualcomm® Atheros® AR8171
- 支援 Qualcomm® Atheros® Security Wake On Internet Technology
- 支援網路喚醒
- 支援 Energy Efficient Ethernet 802.3az
- 支援 PXE

後面板 I/O

- 1 個 PS/2 滑鼠 / 鍵盤接口
- 1 x D-Sub 連接埠
- 1 x DVI-D 連接埠
- 1 x HDMI 連接埠
- 1 x 光纖 SPDIF 輸出連接埠
- 1 x eSATA 接頭
- 4 x USB 2.0 連接埠
- 2 x USB 3.0 連接埠
- 1 x RJ-45 LAN 連接埠，含 LED（ACT/LINK LED 及 SPEED LED）
- HD 音訊插孔：後置喇叭 / 中置 / 低音 / 線路輸入 / 前置喇叭 / 麥克風

儲存裝置

- 2 x SATA3 6.0 Gb/s 接頭，支援 NCQ、AHCI 及熱插拔
- 1 x eSATA 接頭，支援 NCQ、AHCI 及熱插拔

接頭

- 1 x 機殼防護標頭
- 1 x TPM 標頭
- 1 x CPU 風扇接頭 (4-pin)
- 1 x 機殼風扇接頭 (4-pin)
- 1 x 24 pin ATX 電源接頭
- 1 x 4 pin 12V 電源接頭
- 1 x 前面板音訊接頭
- 1 x USB 2.0 排針 (支援 2 USB 2.0 連接埠)

BIOS 功能

- 32Mb AMI UEFI Legal BIOS 含多語 GUI 支援
- ACPI 1.1 符合喚醒自動開機
- 支援 SMBIOS 2.3.1
- CPU、DRAM、PCH 1.05V、PCH 1.5V 電壓多重調整

支援 CD

- 驅動程式、公用程式、防毒軟體 (試用版)、CyberLink MediaEspresso 6.5 Trial、Google Chrome 瀏覽器及工具列、Start8 (30 天試用)

硬體監視器

- CPU / 機殼溫度感應
- CPU / 機殼轉速計
- CPU / 機殼靜音風扇 (允許按照 CPU 溫度自動調整機殼風扇速度)
- CPU / 機殼風扇多重速度控制
- 機殼開啟偵測
- 電壓監控：+12V、+5V、+3.3V、CPU Vcore

作業系統

- 相容 Microsoft® Windows® 8 / 8 64 位元 / 7 / 7 64 位元

認證

- FCC、CE、WHQL
- ErP/EuP Ready (需具備 ErP/EuP ready 電源供應器)

* 如需產品詳細資訊，請上我們的網站：<http://www.asrock.com>



在 Windows® 32 位元作業系統下，因有保留供系統使用記憶體的限制，所以實際記憶體大小可能低於 4GB。Windows® 64 位元作業系統則沒有此類限制。您可使用 ASRock XFast RAM 運用 Windows® 無法使用的記憶體。

1.3 跳線設定

圖例顯示設定跳線的方式。當跳線帽套在針腳上時，該跳線為「短路」。若沒有跳線帽套在針腳上，該跳線為「開啟」。圖例顯示當 3-pin 跳線的跳線蓋套在 pin1 及 pin2 時，這兩個針腳皆為「短路」。

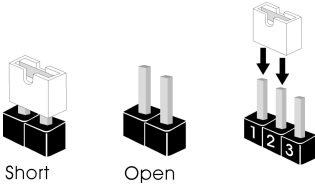

清除 CMOS 跳線

(CLRCMOS1)

(請參閱第 1 頁，編號 3)



預設



清除 CMOS

您可利用 CLRCMOS1 清除 CMOS 中的資料。若要清除及重設系統參數為預設設定，請先關閉電腦電源，再拔下電源供應器的電源線。在等待 15 秒後，請使用跳線帽讓 CLRCMOS1 上的 pin2 及 pin3 短路約 5 秒。不過，請不要在更新 BIOS 後立即清除 CMOS。若您需在更新 BIOS 後立即清除 CMOS，則必須先重新啟動系統，然後於進行清除 CMOS 動作前關機。請注意，只有在取出 CMOS 電池時才會清除密碼、日期、時間及使用者預設設定檔。



若您清除 CMOS，可能會偵測到機殼開啟。請調整 BIOS 選項「清除狀態」，清除先前機殼防護狀態的紀錄。

1.4 板載排針及接頭



板載排針及接頭都不是跳線。請勿將跳線帽套在這些排針及接頭上。將跳線帽套在排針及接頭上，將造成主機板永久性的受損。

系統面板排針
(9-pin PANEL1)
(請參閱第 1 頁，編號 8)

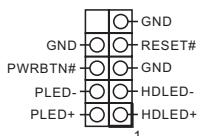

請依照以下的針腳排列將機殼上的電源開關、重設開關及系統狀態指示燈連接至此排針。在連接纜線之前請注意正負針腳。



PWRBTN (電源開關) :

連接至機殼前面板上的電源開關。您可設定使用電源開關關閉系統電源的方式。

RESET (重設開關) :

連接至機殼前面板上的重設開關。若電腦凍結且無法執行正常重新啟動，按下重設開關即可重新啟動電腦。

PLED (系統電源 LED) :

連接至機殼前面板上的電源狀態指示燈。系統正在運作時，此 LED 會亮起。系統進入 S1/S3 睡眠狀態時，LED 會持續閃爍。系統進入 S4 睡眠狀態或關機 (S5) 時，LED 會熄滅。

HDLED (硬碟活動 LED) :

連接至機殼前面板上的硬碟活動 LED。硬碟正在讀取或寫入資料時，LED 會亮起。

各機殼的前面板設計各有不同。前面板模組主要是由電源開關、重設開關、電源 LED、硬碟活動 LED、喇叭及其他裝置組成。將機殼前面板模組連接至此排針時，請確定佈線及針腳指派皆正確相符。

Serial ATA3 接頭

(SATA3_0 :

請參閱第 1 頁，編號 9)

(SATA3_1:

請參閱第 1 頁，編號 10)



這兩組 SATA3 接頭皆支援內部儲存裝置的 SATA 資料纜線，最高可達 6.0 Gb/s 資料傳輸率。

USB 2.0 排針

(9-pin USB10_11)

(請參閱第 1 頁，編號 8)

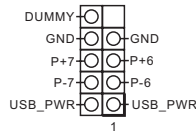

除了 I/O 面板上的兩個 USB 2.0 連接埠外，在本主機板上還有另外一組排針。各 USB 2.0 排針皆可支援兩個連接埠。

前面板音訊排針

(9-pin HD_AUDIO1)

(請參閱第 1 頁，編號 16)

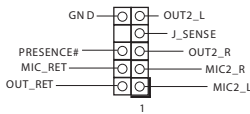

本排針適用於連接音訊裝置至前面板音訊。



- 高解析度音訊支援智慧型音效介面偵測 (Jack Sensing)，但機殼上的面板線必須支援 HDA 才能正確運作。請依本手冊及機殼手冊說明安裝系統。
- 若您使用 AC'97 音訊面板，請按照以下步驟安裝至前面板音訊排針：
 - 將 Mic_IN (MIC) 連接至 MIC2_L。
 - 將 Audio_R (RIN) 連接至 OUT2_R 且將 Audio_L (LIN) 連接至 OUT2_L。
 - 將接地 (GND) 連接至接地 (GND)。
 - MIC_RET 及 OUT_RET 僅供 HD 音訊面板使用。您不需要在 AC'97 音訊面板上連接。
 - 若要啟動前側麥克風，請前往 Realtek 控制面板中的「FrontMic」標籤調整「錄音音量」。

機殼風扇接頭
(4-pin CHA_FAN1)
(請參閱第 1 頁，編號 11)

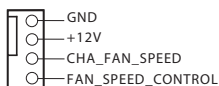

請將風扇纜線連接至風扇接頭，並比對黑線及接地針腳。

CPU 風扇接頭
(4-pin CPU_FAN1)
(請參閱第 1 頁，編號 6)

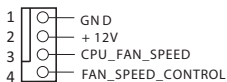

本主機板配備 4-Pin CPU 風扇 (靜音風扇) 接頭。若您計畫連接 3-Pin CPU 風扇，請接至 Pin 1-3。

ATX 電源接頭
(24-pin ATXPWR1)
(請參閱第 1 頁，編號 5)

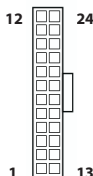

本主機板配備一組 24-pin ATX 電源接頭。若要使用 20-pin ATX 電源供應器，請插入 Pin 1 及 Pin 13。

ATX 12V 電源接頭
(8-pin ATX12V1)
(請參閱第 1 頁，編號 1)



本主機板配備一組 8-pin ATX 12V 電源接頭。若要使用 4-pin ATX 電源供應器，請插入 Pin 1 及 Pin 5。

機殼防護排針
(2-pin C11)
(請參閱第 1 頁，編號 4)



本主機板支援「機殼開啟」偵測功能，可偵測機殼外蓋是否遭移除。若要使用本功能，機殼必須採用機殼防護偵測設計。

TPM 標頭
(17-pin TPMS1)
(請參閱第 1 頁，編號 12)

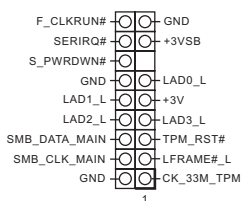

此接頭支援信賴平台模組 (TPM) 系統，可確保儲存金鑰、數位憑證、密碼及資料的安全。TPM 系統也能強化網路安全、保護數位身分並確定平台完整性。

1 Pendahuluan

Terima kasih telah membeli motherboard ASRock H81M-ITX, yakni motherboard andal yang diproduksi di bawah kendali mutu ketat yang sejalan dengan ASRock. Motherboard ini memberikan performa luar biasa dengan desain canggih yang meneguhkan komitmen ASRock terhadap kualitas dan ketahanan.



Karena spesifikasi motherboard dan perangkat lunak BIOS dapat di-update, maka isi dokumentasi ini akan berubah sewaktu-waktu tanpa pemberitahuan sebelumnya. Jika terdapat perubahan pada dokumentasi ini, maka versi baru akan tersedia di situs web ASRock tanpa pemberitahuan lebih lanjut. Jika Anda memerlukan dukungan teknis terkait motherboard ini, kunjungi situs web kami untuk mendapatkan informasi khusus tentang model yang Anda gunakan. Anda juga dapat menemukan kartu VGA dan daftar dukungan CPU terkini di situs web ASRock. Situs web ASRock <http://www.asrock.com>.

1.1 Isi Kemasan

- Motherboard ASRock H81M-ITX (Bentuk dan Ukuran Mini-ITX)
- Panduan Ringkas ASRock H81M-ITX
- CD Dukungan ASRock H81M-ITX
- 2 x Kabel Data SATA (Serial ATA) (Opsional)
- 1 x Pelindung Panel I/O

1.2 Spesifikasi

Platform

- Bentuk dan Ukuran Mini-ITX
- Desain Kapasitor Solid

CPU

- Mendukung Intel® Core™ i7 / i5 / i3 Generasi Ke-4 / Xeon® / Pentium® / Celeron® dalam Paket LGA1150
- Desain 4 Fase Daya
- Mendukung Teknologi Intel® Turbo Boost 2.0

Chipset

- Intel® H81

Memori

- Teknologi Memori DDR3 Kanal Ganda
- 2 x Slot DDR3 DIMM
- Mendukung DDR3 1600/1333/1066 non-ECC, memori tanpa buffer
- Kapasitas maksimum memori sistem: 16GB (lihat PERHATIAN)
- Mendukung Intel® Extreme Memory Profile (XMP) 1.3/1.2

Slot Ekspansi

- 1 x Slot PCI Express 2.0 x16

Grafis

- Intel® HD Graphics Built-in Visuals dan output VGA hanya didukung dengan prosesor yang terintegrasi GPU.
- Mendukung Intel® HD Graphics Built-in Visuals: Intel® Quick Sync Video dengan AVC, MVC (S3D), dan MPEG-2 Full HW Encode1, Intel® InTru™ 3D, Teknologi Intel® Clear Video HD, Intel® Insider™, Intel® HD Graphics 4400/4600
- Pixel Shader 5.0, DirectX 11.1
- Memori bersama maksimum 1792MB
- Tiga pilihan output VGA: D-Sub, DVI-D, dan HDMI
- Mendukung Teknologi HDMI dengan resolusi maksimum hingga 1920x1200 @ 60Hz
- Mendukung DVI-D dengan resolusi maksimum hingga 1920x1200 @ 60Hz

- Mendukung D-Sub dengan resolusi maksimum hingga 1920x1200 @ 60Hz
- Mendukung Auto Lip Sync, Deep Color (12bpc), xvYCC, dan HBR (High Bit Rate Audio) dengan HDMI (memerlukan monitor HDMI yang kompatibel)
- Mendukung fungsi HDCP dengan port DVI-D dan HDMI
- Mendukung pemutaran Full HD 1080p Blu-ray (BD) dengan port DVI-D dan HDMI

Audio

- Audio HD 7.1 CH dengan Perlindungan Konten (Realtek ALC892 Audio Codec)
- Mendukung audio Blu-ray premium

LAN

- PCIE x1 Gigabit LAN 10/100/1000 Mb/s
- Qualcomm® Atheros® AR8171
- Mendukung Teknologi Qualcomm® Atheros® Security Wake On Internet
- Mendukung Wake-On-LAN
- Mendukung Energy Efficient Ethernet 802,3az
- Mendukung PXE

Panel I/O Belakang

- 1 x Port Mouse/Keyboard PS/2
- 1 x Port D-Sub
- 1 x Port DVI-D
- 1 x Port HDMI
- 1 x Port SPDIF Out Optik
- 1 x Konektor eSATA
- 4 x Port USB 2.0
- 2 x Port USB 3.0
- 1 x Port LAN RJ-45 dengan LED (ACT/LINK LED dan SPEED LED)
- Soket Audio HD: Speaker Belakang/Tengah/Bas/Saluran masuk/Speaker Depan/Mikrofon

- Penyimpanan**
- 2 x Konektor SATA3 6,0 Gb/s, mendukung fungsi NCQ, AHCI, dan Hot Plug
 - 1 x Konektor eSATA, mendukung fungsi NCQ, AHCI, dan Hot Plug

- Konektor**
- 1 x Header Intrusi Chassis
 - 1 x Header TPM
 - 1 x Konektor kipas CPU (4-pin)
 - 1 x Konektor kipas chassis (4-pin)
 - 1 x Konektor daya ATX 24 pin
 - 1 x Konektor daya 12V 4 pin
 - 1 x Konektor audio panel depan
 - 1 x Header USB 2.0 (mendukung 2 port USB 2.0)

- Fitur BIOS**
- 32Mb AMI UEFI Legal BIOS dengan dukungan GUI Multibahasa
 - ACPI 1.1 Kompatibel dengan Aktivitas Pengaktifan
 - Dukungan SMBIOS 2.3.1
 - Multipengatur Tegangan CPU, DRAM, PCH 1,05V, PCH 1,5V

- Dukungan CD**
- Driver, Utilitas, Perangkat Lunak AntiVirus (Versi Uji Coba), CyberLink MediaEspresso 6.5 Uji Coba, Google Chrome Browser dan Toolbar, Start8 (uji coba 30 hari)

- Perangkat Keras Monitor**
- Sensor Suhu CPU/Chassis
 - Takometer CPU/Chassis
 - Kipas Hening CPU/Chassis (Memungkinkan Penyesuaian Otomatis Kecepatan Kipas Chassis Berdasarkan Suhu CPU)
 - Kontrol Multikecepatan Kipas CPU/Chassis
 - Deteksi CASE OPEN
 - Pemantauan Tegangan: +12V, +5V, +3,3V, CPU Vcore

- OS**
- Kompatibel dengan Microsoft® Windows® 8 / 8 64-bit / 7 / 7 64-bit

- Sertifikasi**
- FCC, CE, WHQL
 - Siap untuk ErP/EuP (memerlukan catu daya untuk ErP/EuP)

* Untuk informasi tentang produk rinci, kunjungi situs web kami: <http://www.asrock.com>



Karena keterbatasan, ukuran memori sebenarnya mungkin kurang dari 4GB karena akan digunakan sistem berdasarkan sistem operasi Windows® 32-bit. Sistem operasi Windows® 64-bit tidak memiliki keterbatasan tersebut. Anda dapat menggunakan ASRock XFast RAM untuk memanfaatkan memori yang tidak dapat digunakan Windows® tersebut.

1.3 Konfigurasi Jumper

Gambar menunjukkan cara mengkonfigurasi jumper. Bila penutup jumper diletakkan pada pin, maka jumper akan “Pendek”. Jika tidak ada penutup jumper yang diletakkan pada pin, maka jumper akan “Terbuka”. Gambar menunjukkan jumper 3-pin, yakni pin1 dan pin2 menjadi "Pendek" bila penutup jumper diletakkan pada 2 pin tersebut.

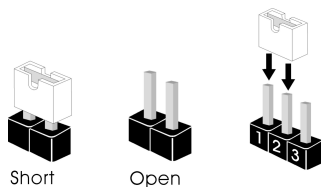

Clear CMOS Jumper
(CLRCMOS1)
(lihat hal. 1, No. 3)



CLRCMOS1 memungkinkan Anda mengosongkan data di CMOS. Untuk mengosongkan dan mengatur ulang parameter sistem ke konfigurasi default, matikan komputer, lalu lepas kabel daya dari catu daya. Setelah menunggu selama 15 detik, gunakan penutup jumper untuk memendekkan pin2 dan pin3 pada CLRCMOS1 selama 5 detik. Namun, jangan kosongkan CMOS tepat setelah Anda meng-update BIOS. Jika Anda harus mengosongkan CMOS setelah selesai meng-update BIOS, boot up dulu sistem, lalu matikan sebelum melakukan tindakan clear-CMOS. Perhatikan bahwa sandi, tanggal, waktu, dan profil default pengguna akan dikosongkan hanya jika baterai CMOS dikeluarkan.



Jika Anda mengosongkan CMOS, maka rangka terbuka mungkin akan terdeteksi. Atur pilihan “Clear Status” BIOS untuk mengosongkan data status intrusi chassis sebelumnya.

1.4 Header dan Konektor Onboard



Header dan konektor terpasang BUKANLAH jumper. JANGAN letakkan penutup jumper pada header dan konektor tersebut. Meletakkan penutup jumper pada header dan konektor akan mengakibatkan kerusakan permanen pada motherboard.

Header Panel Sistem
(PANEL1 9-pin)
(lihat hal. 1, No. 8)

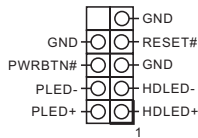

Sambungkan switch daya, atur ulang indikator status sistem dan switch daya pada chassis ke header tersebut berdasarkan penetapan pin di bawah ini. Perhatikan pin positif dan negatif sebelum menyambungkan kabel.



PWRBTN (Switch Daya):

Sambungkan ke switch daya pada panel depan chassis. Anda dapat mengkonfigurasi cara mematikan sistem menggunakan switch daya.

RESET (Switch Atur Ulang):

Sambungkan ke switch atur ulang pada panel depan chassis. Tekan switch atur ulang untuk mengatur ulang komputer jika komputer tidak merespons dan gagal melakukan pengaktifan ulang normal.

PLED (LED Daya Sistem):

Sambungkan ke indikator status daya pada panel depan chassis. LED akan menyala bila sistem sedang beroperasi. LED akan terus berkedip bila sistem dalam kondisi tidur S1/S3. LED akan mati bila sistem dalam kondisi tidur S4 atau mati (S5).

HDLED (LED Aktivitas Hard Drive):

Sambungkan ke LED aktivitas hard drive pada panel depan chassis. LED akan menyala bila hard drive sedang membaca atau menulis data.

Desain panel depan dapat berbeda menurut chassis. Modul panel depan biasanya terdiri atas switch daya, switch atur ulang, LED daya, LED aktivitas hard drive, speaker, dll. Bila menyambungkan modul panel depan chassis ke header, pastikan penetapan kabel dan pin disesuaikan dengan benar.

Konektor Serial ATA3

(SATA3_0:

lihat hal. 1, No. 9)

(SATA3_1:

lihat hal. 1, No. 10)



Dua konektor SATA3 ini mendukung kabel data SATA untuk perangkat penyimpanan internal dengan kecepatan transfer data hingga 6,0 Gb/s.

Header USB 2.0

(USB10_11 9-pin)

(lihat hal. 1, No. 8)

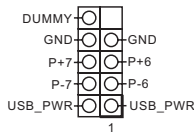

Selain dua port USB 2.0 pada panel I/O, terdapat satu header pada motherboard ini. Masing-masing header USB 2.0 dapat mendukung dua port.

Header Audio Panel

Depan

(HD_AUDIO1 9-pin)

(lihat hal. 1, No. 16)

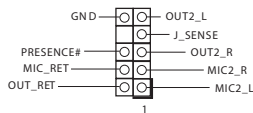

Header ini untuk menyambungkan perangkat audio ke panel audio depan.



1. *Audio Definisi Tinggi mendukung Sensor Soket, namun kabel panel pada chassis harus mendukung HDA agar berfungsi dengan benar. Ikuti petunjuk dalam panduan pengguna ini dan panduan pengguna chassis untuk menginstal sistem.*
2. *Jika Anda menggunakan panel audio AC'97, pasang ke header audio panel depan dengan melakukan langkah-langkah di bawah ini:*
 - A. *Sambungkan Mic_IN (MIC) ke MIC2_L.*
 - B. *Sambungkan Audio_R (RIN) ke OUT2_R dan Audio_L (LIN) ke OUT2_L.*
 - C. *Sambungkan Ground (GND) ke Ground (GND).*
 - D. *MIC_RET dan OUT_RET hanya untuk panel audio HD. Anda tidak perlu menyambungkannya untuk panel audio AC'97.*
 - E. *Untuk mengaktifkan mikrofon depan, buka tab "FrontMic" pada Panel kontrol Realtek, lalu sesuaikan "Volume Perekaman".*

Konektor Kipas Chassis
(CHA_FAN1 4-pin)
(lihat hal. 1, No. 11)

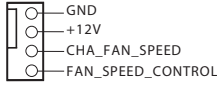

Sambungkan kabel kipas ke konektor kipas, lalu cocokkan kabel hitam dengan pin ground.

Konektor Kipas CPU
(CPU_FAN1 4-pin)
(lihat hal. 1, No. 6)

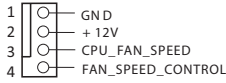

Motherboard ini memberikan konektor kipas CPU 4-Pin (Kipas Hening). Jika Anda berencana untuk menyambungkan kipas CPU 3-Pin, sambungkan ke Pin 1-3.

Konektor Daya ATX
(ATXPWR1 24-pin)
(lihat hal. 1, No. 5)

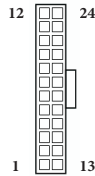

Motherboard ini memberikan konektor daya ATX 24-pin. Untuk menggunakan catu daya ATX 20-pin, pasang bersama Pin 1 dan Pin 13.

Konektor Daya ATX 12V
(ATX12V1 8-pin)
(lihat hal. 1, No. 1)



Motherboard ini memberikan konektor daya ATX 12V 8-pin. Untuk menggunakan catu daya ATX 4-pin, pasang bersama Pin 1 dan Pin 5.

Header
Intrusi Chassis (CI1)
2-pin)
(lihat hal. 1, No. 4)

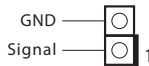

Motherboard ini mendukung fitur deteksi CASE OPEN yang mendeteksi jika celah chassis telah dilepas. Fitur ini memerlukan chassis dengan desain deteksi intrusi chassis.

Header TPM
(TPMS1 17-pin)
(lihat hal. 1, No. 12)

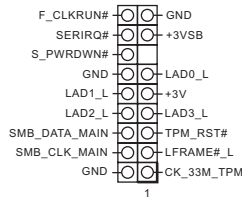

Konektor ini mendukung sistem TPM (Trusted Platform Module), yang dapat menyimpan kode kunci, sertifikat digital, sandi, dan data secara aman. Sistem TPM juga membantu meningkatkan keamanan jaringan, melindungi identitas digital, dan memastikan integritas platform.

Contact Information

If you need to contact ASRock or want to know more about ASRock, you're welcome to visit ASRock's website at <http://www.asrock.com>; or you may contact your dealer for further information. For technical questions, please submit a support request form at <http://www.asrock.com/support/tsd.asp>

ASRock Incorporation

2F., No.37, Sec. 2, Jhongyang S. Rd., Beitou District,

Taipei City 112, Taiwan (R.O.C.)

ASRock EUROPE B.V.

Bijsterhuizen 3151

6604 LV Wijchen

The Netherlands

Phone: +31-24-345-44-33

Fax: +31-24-345-44-38

ASRock America, Inc.

13848 Magnolia Ave, Chino, CA91710

U.S.A.

Phone: +1-909-590-8308

Fax: +1-909-590-1026